

WEST COAST FRAME TENTS

10' and 20' wide

(mid-kit and sectional canopy application)

ASSEMBLY INSTRUCTIONS



West Coast Frame Tent (OVERVIEW)

Note: Any reference to Mid-Kits applies to 10ft. and 20ft. kits

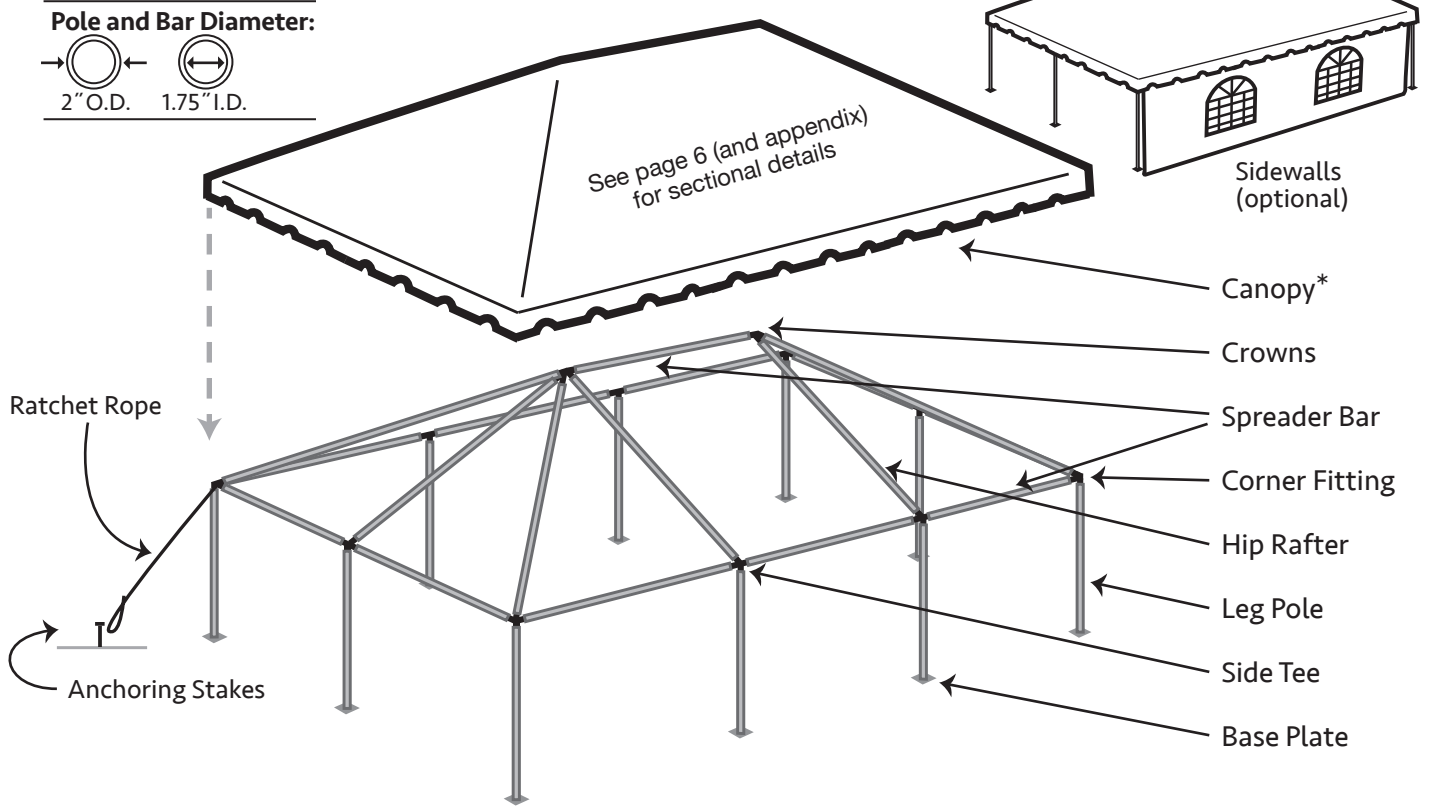

Refer to (appendix) for basic spreader, rafter, fitting and Mid-Kit layout.











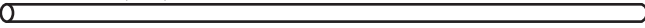
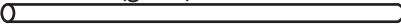

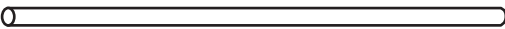
*Also for CANOPY SEAM LOCATIONS.

(example, not size specific)

West Coast Frame Tent (SPECIFICATIONS: 10x30 & 20x50)

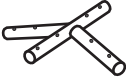
Width/ Length/ Area	10 ft./ 30 ft./ 300 ft ²	Water Repellency	Waterproof
Width/ Length/ Area	20 ft./ 50 ft./ 1,000 ft ²	Snow Load	None
Eave Height	7' / 2.1 m (opt. 8' / 2.4m)	Flame Resistant	Yes
Pitch	5' / 1.5 m	UV Resistant	Yes
Series	West Coast	Mold and Mildew Resistant	Yes
Class	Frame	Frame / Pole Material	Aluminum
Center Pole	No	Longest Component	14'4" / 4.4m
Style / Shape	Traditional Tent	Persons required for setup	3-5
Expandable	No (sectional tops only)	Occupancy (10x30)	30 Sit Down Dinner
Fabric Material	PVC Coated Polyester	Occupancy (cont.)	50 Cathedral Seating
Fabric Material Weight	16 oz. / yd ² / 540 gsm	Occupancy (20x50)	90 Sit Down Dinner
Fabric Translucency	Block-out	Occupancy (cont.)	150 Cathedral Seating

STEP 1. CHECK ITEM LIST (10x20 and 20x40) (other standard size tent manuals and parts can be found in the online listings)

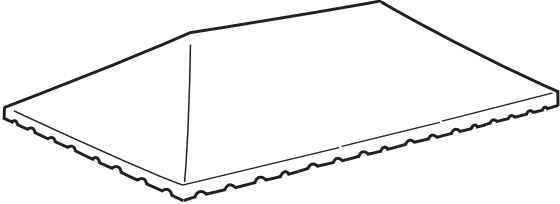
Item	Illustration (all parts available for replacement)	Size	Quantity
Hip Rafters (yellow/red)	 Size: 6'-10" (yellow) SKU: BT-FWAST082	10x20	4
	 Size: 14'-4" (red) SKU: BT-FWAST172	20x40	4
Rafters (green/red)	 Size: 4'-11" (green) SKU: BT-FWAST059	10x20	2
	 Size: 10'-6" (green) SKU: BT-FWAST126	20x40	8
Spreaders (white/red)	 Size: 9'-4" (white)	10x20	7
	SKU: BT-FWAST112	20x40	14
Leg Poles / Base (black) / Plates	 Sizes: 6'-8" (brown) SKU: BT-FWAST080	10x20	6 +2/kit
	 SKU: BT-FWBWP	20x40	12 +2/kit
Corner Fittings		10x20	4
	SKU: BT-FWCRN	20x40	4
Side Tee Fittings		10x20	2
	SKU: BT-FW4WST	20x40	8
6-Way Crowns		20x40	none
	SKU: BT-FW6WC		2
8-Way Crowns			none none
Ridge Crowns (Crowns)		20x40	none
	SKU: BT-FWRC		1
Rope- 12ft., w/ loop		10x20	6 +2/kit
	SKU: BT-TAROPE	20x40	12
'R' Pins		10x20	38 +16/kit
	SKU: BT-FWRP25	20x40	76 +14/kit
Single Head Stakes (3/4" x 30")		10x20	6 +2/kit
	SKU: BT-34SH30	20x40	12 +2/kit
Canopy Top		10x20	1
	SECTIONAL TOPS MUST BE USED	20x40	1
SEE APPENDIX FOR MID-KIT PARTS			(see appendix for more info)

STEP 1. CONTINUED

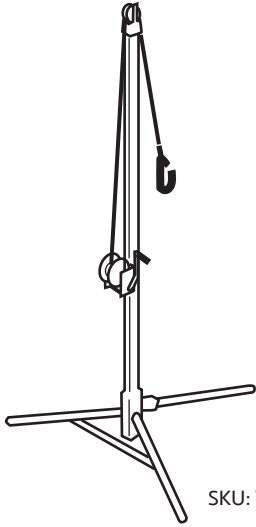

SKU: WCF-JACK-12

This item is very important in the process, **Frame Tent Jack** (sold separately). Some West Coast Frame tents require *frame tent jacks*—and larger tents require multiple jacks.

General rules are; work on the long side, one side at a time, and never place jack in the middle of a spreader bar.

(set-up and use can be found on internet)

Tent Size	Estimated Quantity
10 x 10	none
10 x 20	none
10 x 30	2
15 x 15	none
15 x 30	2
20 x 20	none
20 x 30	2
20 x 40	3
20 x 50	3
20 x 60	4
20 x 70	4

Recommended Tools

- 6ft. step ladders
- Sledge Hammer
- Tape Measure
- Work boots
- Stake Driver (for larger tents)

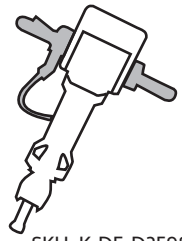

SKU: K-DE-D25980K

WARNING

Tent products are manufactured for use as temporary structure and do not meet structural code, unless specified. Since weather is unpredictable, the customer must incorporate their own good judgment, common sense & knowledge of local conditions with the installation instruction guidelines.

The customer is responsible to anticipate weather severity for proper time and method of construction.

'BEFORE YOU DIG' (hammer stakes)

By Law you are required to contact your local "Call before you dig" number before you plan to dig. After calling, your local utility company will mark the location of underground utility lines. Laws from state to state vary on how far in advance you must call.

Planning ahead and checking with your state's program is always a smart idea. Failure to obtain a line location before digging can result in a substantial fine. Please find your local "call before your dig number" by going to call811.com.

STEP 2. SAFETY CHECK LIST



- When building or assembling anything above shoulder height, wear a hard hat
- Steel toe boots are recommended
- Inspect the site, look for overhead and underground obstructions— such as utilities
- Call your local utility to have utility lines marked (call 3–5 days ahead)— **call811.com** is a good resource— 'click' 811 in Your State
- Inspect all ropes and tie lines
- Inspect poles, making sure there are no bends or breaks
- Replace or repair any items in poor condition

STEP 3. LAYOUT FRAME

Position parts in the exact location of finished tent

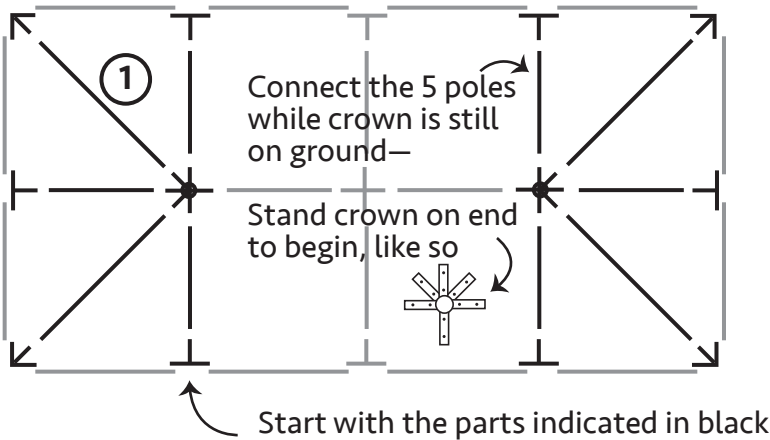

- Place all tent poles and fittings on the ground in the location you have selected for the finished tent
- This layout illustrates a 20 x 40 tent — see (**appendix A**) for your specific size, layout and pole sizes
- 1) Start with the crown and its connecting poles—the drawing shows the correct position of the crown—secure these parts using (2) 'R' pins per pole
- See (**figure A.**) for 'R' pin usage
- Stand these two end assemblies up, to connect the ridge parts next

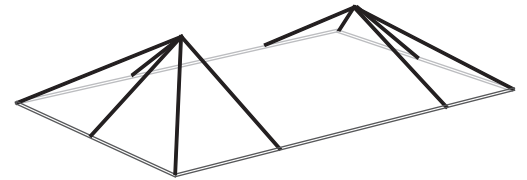

(FIGURE A.) 'R' PIN AND ALIGNMENT HOLE

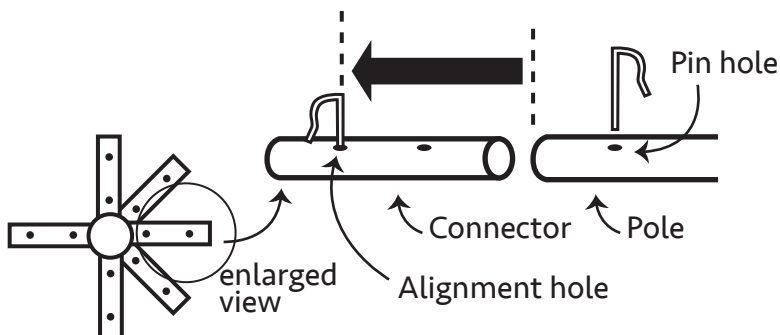

- All connection will be made using this method—2 pins needed
- Insert a pin, halfway, into the alignment hole—this will act as *stop*, for spreader and rafter bars
- Slide pole (spreader, rafter etc.), onto the appropriate connector—touch the *alignment pin*, as a guide
- The pin holes are now lined up—insert the second 'R' pin, all the way, until it locks in place

Reminder:

Frame plans and connector positions, for your tent, appear in the appendix

STEP 4. RIDGE AND PERIMETER

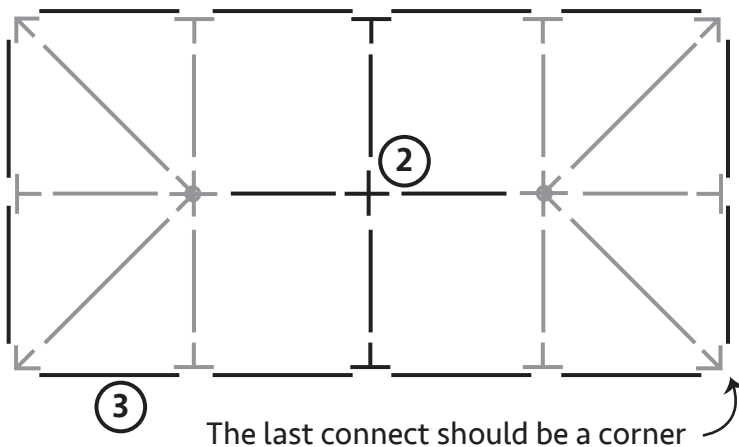

- 2) Connect the ridge line next (15x30 or larger), crowns and spreaders
- While standing on a ladder(s) make all connections from end to end
- If you are short of people, use a tent jack to hold horizontal poles
- 3) Lastly, connect all perimeter bars to the upper spreaders and rafter bars
- When working around the perimeter, the last connection should be at a corner, *not* a side tee
- The frame should now be complete

(example, not size specific)

STEP 5. COMPLETED FRAME

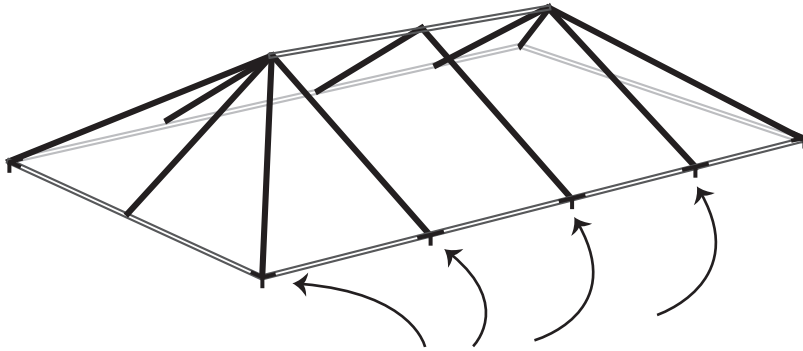

If repositioning is necessary, try to have one person lift at each fitting, all the way around

(Option: add 20ft. Cable(s) at this time, if you choose)

(example, not size specific)

- Now that the frame portion is complete and while the frame is still on the ground, double check the 'R'-pins
- Also, with plenty of hands on deck, lift and adjust frame position if needed, at this point
- Always lift at a side or corner fitting

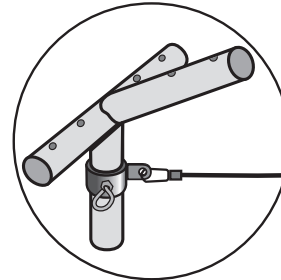

20ft. CABLE KIT OPTION:

The Cable and Bracket Kit supports the frame structure by preventing spreading of the frame—this maintains the correct tent width—making attaching the tent top easier. (visit TentandTable.com)

STEP 6. ANCHOR ROPES

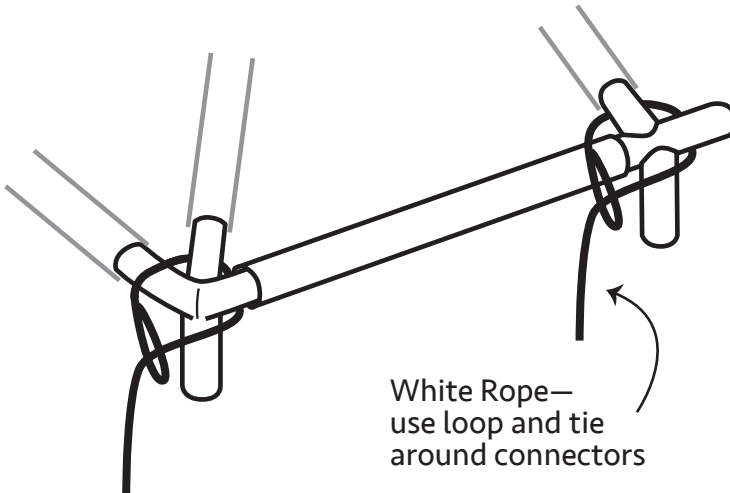

White Rope—
use loop and tie
around connectors

- While frame is still on the ground, tie anchor ropes to the frame
- The ropes will be secured to the tent stakes at the end of the assembly
- One rope per leg pole
- The ropes go under and over, to prevent them from sliding away from leg—see **(drawing)**

Note: this step can occur after the leg poles have been installed and the frame is elevated

STEP 7. CANOPY

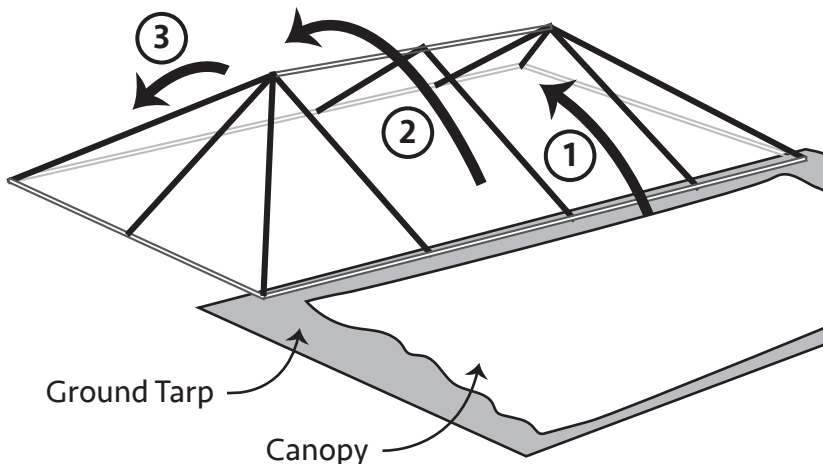

Ground Tarp

Canopy

- Once again, while frame is still on the ground, lay down a tarp(s), to protect canopy—arrange canopy along one of the long sides of the tent
- (See page 6 for Canopy Lacing instructions)**
- Place a ladder(s) next to ridge spreaders —as many as it takes to easily to pull canopy over ridge
 - One person needed for every 10ft of tent
- 1) In unison, pull canopy up one side—'flapping' in the beginning, to create lift —then stop
 - 2) Have most people stay on the ground, and a couple people on ladders—pull canopy over the ridge
 - 3) Pull down the other side—'flapping' for all three steps

Sectional Canopy and Mid-Kit (OVERVIEW)

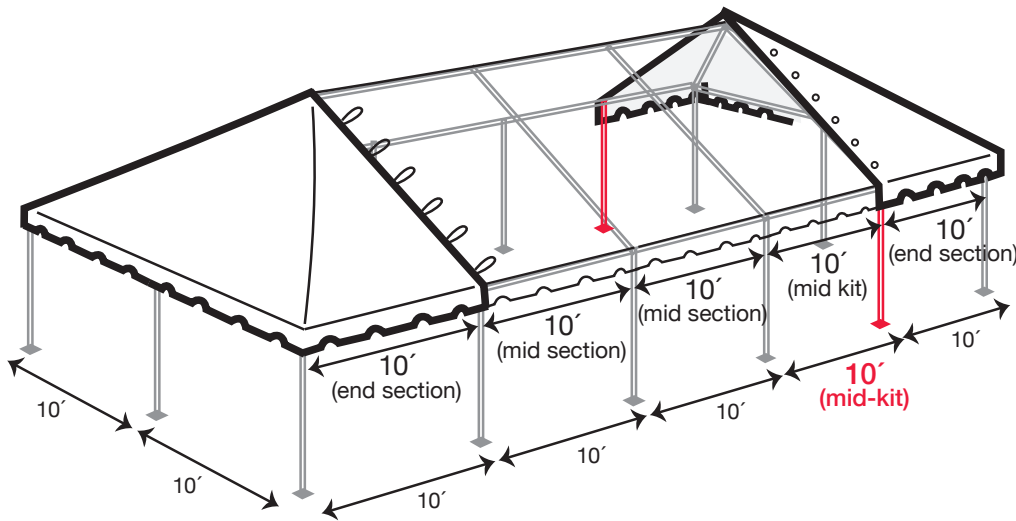

- **Canopies** for non-standard tents are custom 'sectional builds'
- 10 wide tents have 5ft. long ends
- 20 wide tents have 10ft. long ends
- **Mid-kits:** For each additional 10ft. of tent length a Mid-Kit is added— Start with a standard tent frame close to the desired size and go from there

LACING the CANOPY

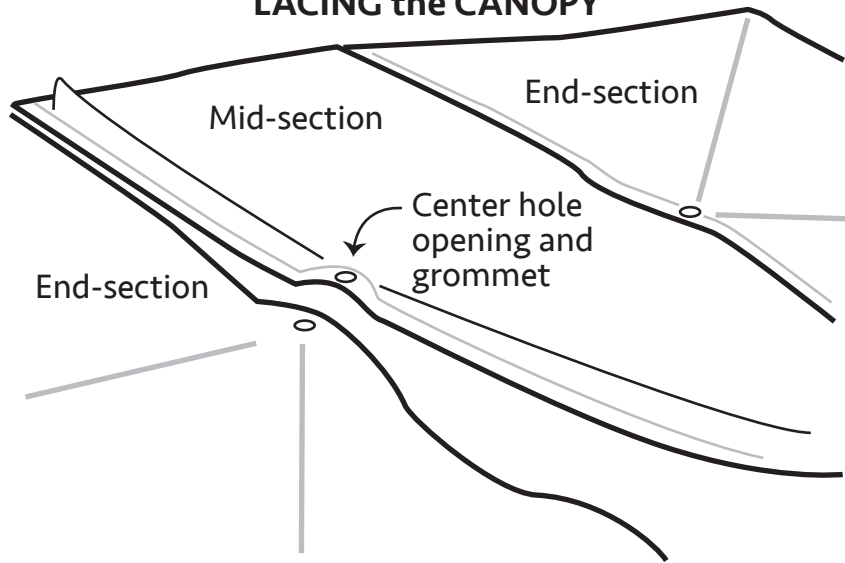

- Lace sections together— start at center and work outward
- A basic 40ft. tent will have two canopy sections—with one 'mid' section for every additional 20ft of tent
- Lace the loops and snap the closures, See **(figure A)**

Special Note:

- For 30', 40' and 60' wide tents, a two piece **crown connector** is provided, to help secure the sections together
- Take it up through the center grommet(s), then cap it with the nut end
- The center pole would then get installed in the *connector*



FIGURE A.

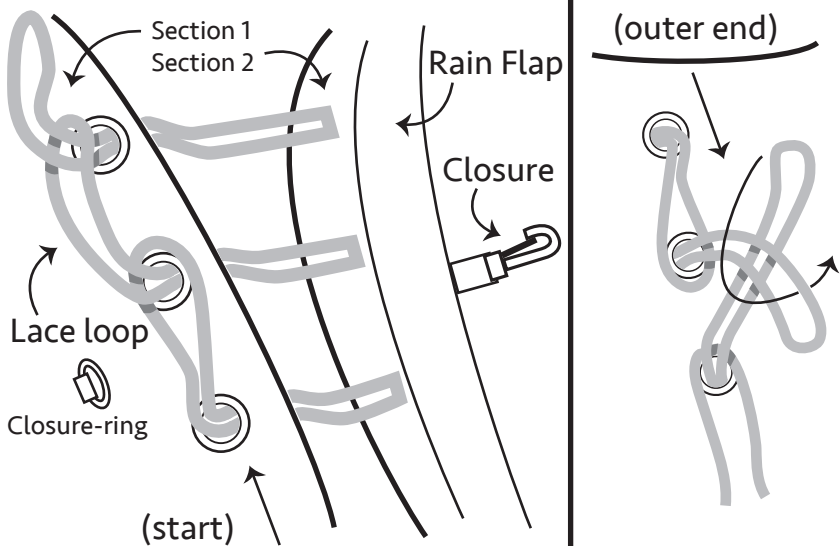

- Starting at Center ridge, push first loop through corresponding grommet
- Continue lacing the loops, from the middle out—pull tight at every loop, as you go
- Snap the closures and close rain flap as you progress outward
- When you get toward the outer end, lace the last two or three loops backwards and tie off the connecting loops
- Last, attach sections using ring and clip



STEP 8. CANOPY CORNERS

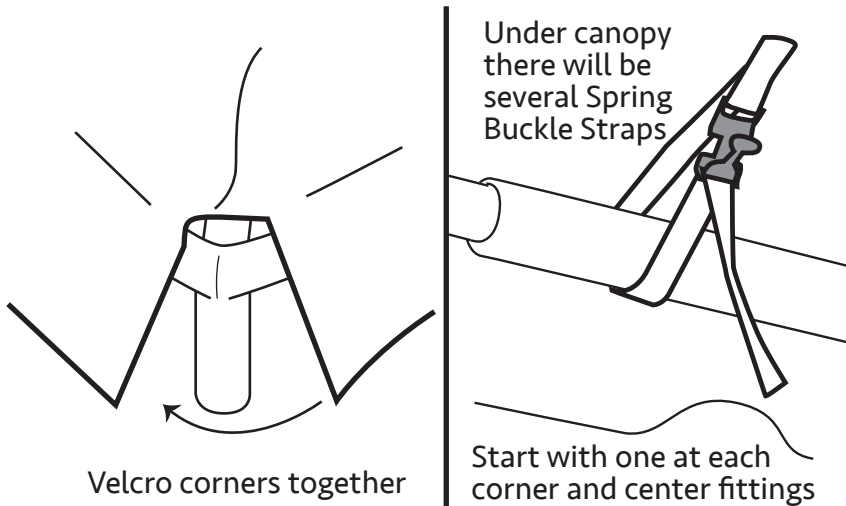

- After canopy is pulled over frame and corners are pulled into position, velcro corner seams together, loosely—tighten after legs are installed
- The canopy should be attached to the frame, before legs are connected—secure some of the spring buckle straps, to keep canopy in place—start near corners and center fittings
- Spring buckle straps are located on the underside of canopy
- Secure the remaining straps after legs are installed on one side and secure—it's easier at this height—Final tightening happens after legs are installed (**step 10**)

STEP 9. BASE PLATES

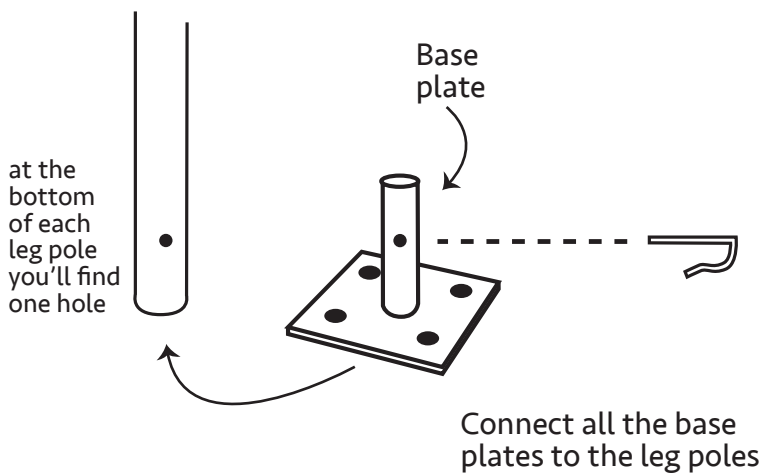

- Before the tent is raised, prepare the leg poles
- Place poles on top of base plate and secure with 'R' pins
- Do this for all the leg poles

STEP 10. INSTALLING LEGS (smaller tents)

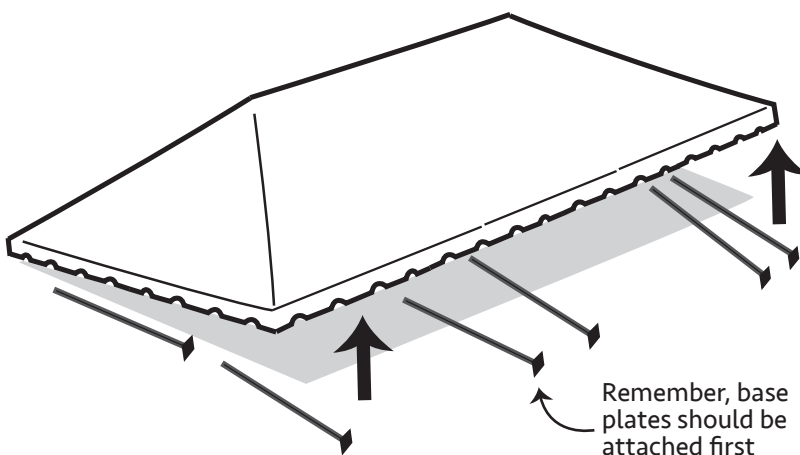

- For smaller tents, (10x10, 10x20, 15x15, 20x20) three or four people should be able to raise the frame and install the leg poles
- Locate one of the long sides of the frame—this will be raised first, while the opposite side remains on the ground
- **Important:** Lift the entire side of the frame at once (not one corner)
- Install all the legs on this side—secure with 'R' pins—
- Repeat for opposite side, then install legs for the remaining two sides
- *Double check the canopy corners—pull them down tight and straight*
- **Important:** tighten spring buckle straps—for security and to help pull canopy corners into place

STEP 10. INSTALLING LEGS (15x30 and larger tents)

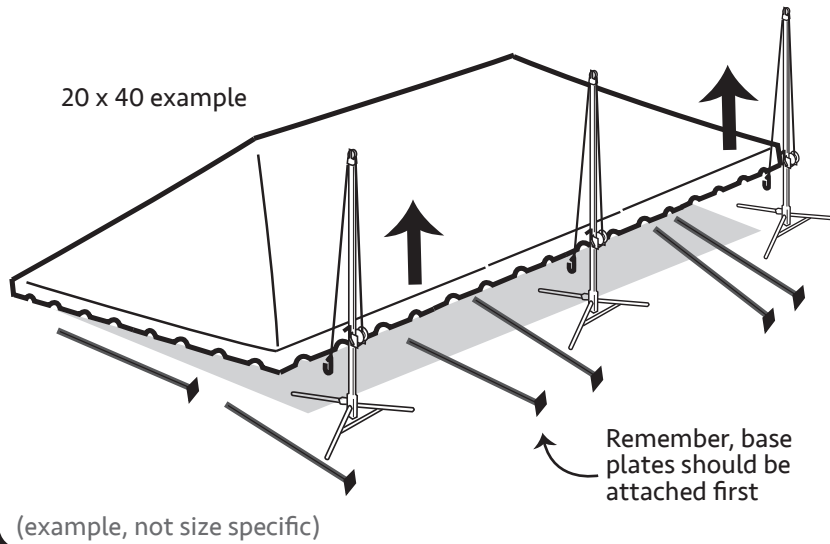

- For larger tents, (15x30 and larger) frame tent jacks should be used to raise the frame and install the leg poles
- Locate one of the long sides of the frame—this will be raised first, while the opposite side remains on the ground
- **Important:** Lift the entire side of the frame at once (not one corner)—crank jacks in unison
- General rules are; work on the long side, one side at a time, and **never** place jack in the middle of a spreader bar*
- Install all the legs on this side—secure with 'R' pins
- Repeat for opposite side, then install legs for the remaining two sides
- **Important:** tighten spring buckle straps—for security and to help pull canopy corners into place

STEP 11. STAKE LINE

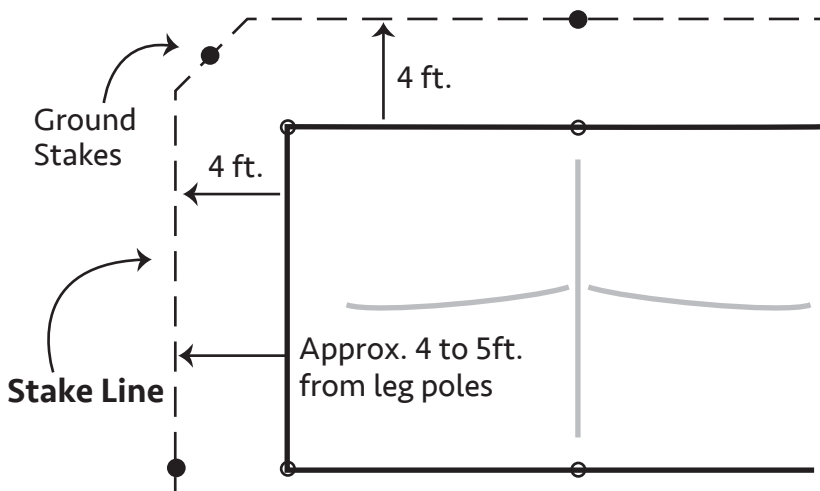

- **Double check leg poles**—making sure each pole is straight and lined up correctly, while tent jacks are still handy
- Once the tent is vertical and all the leg poles are attached, begin the process of staking the tent—with plenty of hands on deck, lift and adjust tent position if needed, first
- Measure 4 ft. out from each leg pole and place a stake in the ground
- Stakes should look uniform, around the tent—and 6 inches above ground see (figure B)
- Stakes should then be hand hammered or for larger installs, use a stake driver

(FIGURE B.) HAMMERING STAKES

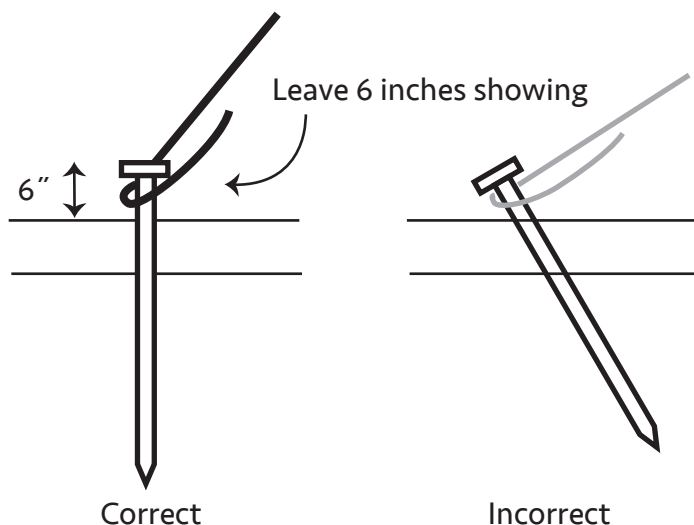

- Ground stakes should be hammered in vertical, not angled (sledge hammer required)
- Complete the hammering process by driving the stakes in and leaving 6 inches showing
- Connection of ropes to ground stakes, can be made with a few different secure knots (see figure C, page 8) for one of the more commonly used knots

STEP 12. SECURING ROPES

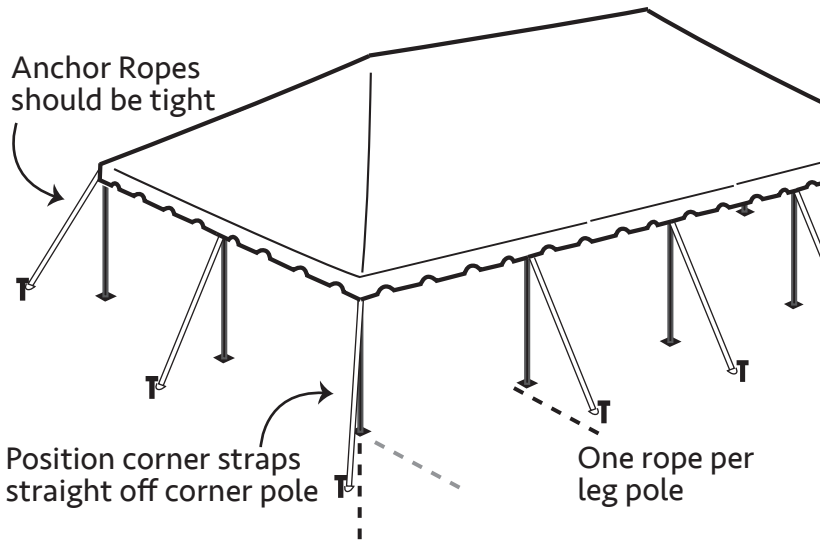

- As the assembly nears completion it is time to tighten all ropes/ratchet straps
- Keep an eye any lean that might be caused by the tightening process
- Go around the tent, make adjustments for any leg pole and tent lean
- Smaller tents use ropes to secure the tent to the stakes— see (figure C)
- Finally, secure any remaining spring buckle straps, under the canopy, that were not secured in step 8

(FIGURE C.) CLOVE-HITCH KNOT

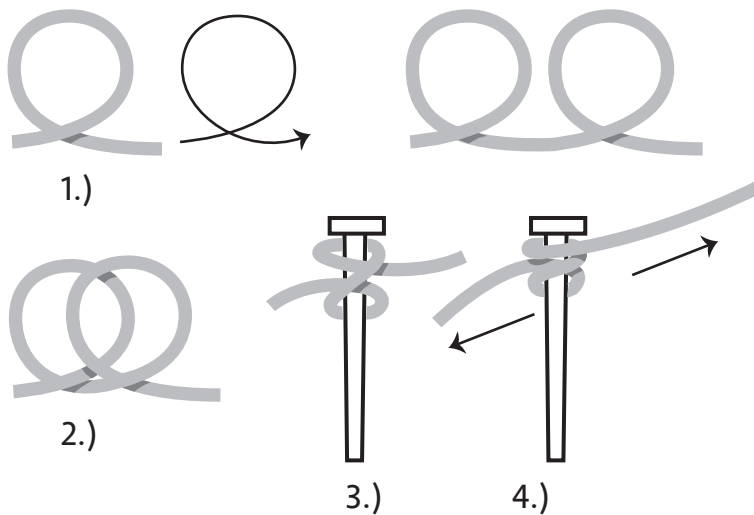

- A commonly used knot for securing a rope to stake is the *clove-hitch*
- 1.) Make two loops
- 2.) Cross loops by placing second loop over the first
- 3.) Place the combined loops over stake
Option: loops can be form directly on stake
- 4.) Pull on both ends to tighten rope
Note: outward force tightens and inward force loosens the knot—when making adjustments
- 5.) Excess line should be pulled half-way up the rope and tied off

FINISHED TENT (20x40)

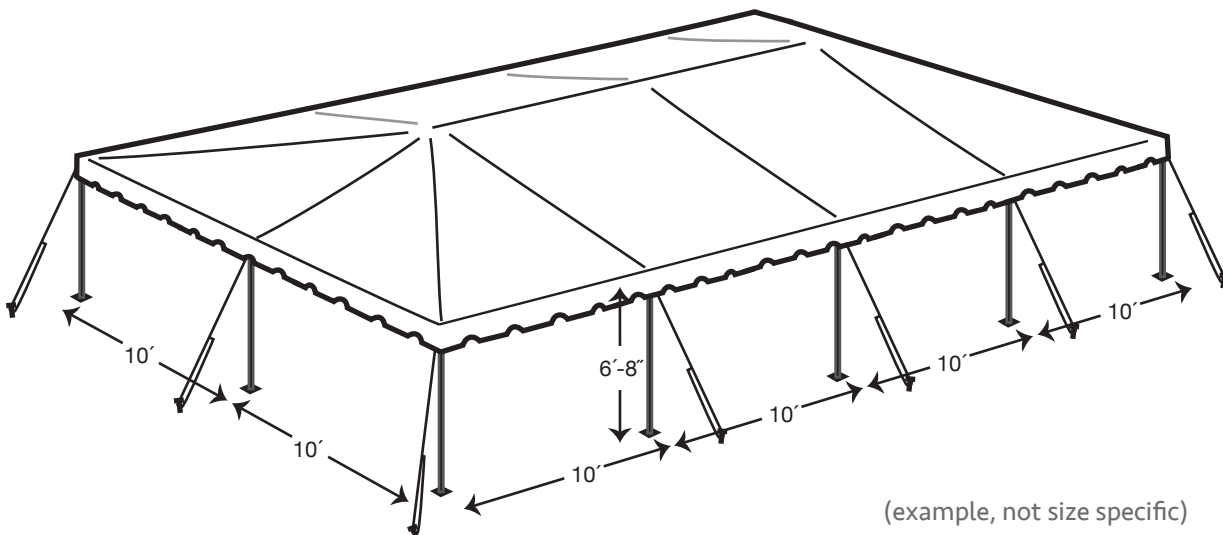

WIND / RAIN / SNOW – IMPORTANT INFORMATION!:**WIND!**

Wind can cause the ratchet assemblies and stakes to loosen, or cause the poles to **sink** or shift through constant movement and vibration – the tension of the tent will be negatively altered.

Follow these steps to provide extra security and safety during windy conditions:

- Very important, do routine maintenance checks – be sure to check proper tension regarding the ratchet assemblies, throughout the day/event. This is critical, if your tent must stay up, in moderate windy conditions.
- In the case of strong winds, remove any sidewalls. This will allow the wind to pass through the tent, diminishing major upward pressure on the tent top.
- Additional security can be achieved by adding additional stakes and ropes/straps to corners— and to the 'wind side' of the tent.
- When anticipating windy conditions, perform a **soil test** to determine proper staking:
 - 1.) drive a large steel stake approx. 20 in. into soil, vertically
 - 2.) measure the distance from the ground to the top of stake
 - 3.) with a 16lb. sledge hammer, strike stake with an average blow (don't over hit)
 - 4.) measure the **movement/hold strength**: (0.2in./2500lbs) (0.3–.5in./1600lbs) (0.6–1.5in./800lbs) (1.6–3in./400lbs) (3–6in./200lbs) (> 6in./100lbs) Double or triple staking might be necessary, 10in. behind primary stake (see figure D). [search web for: **tent.IFAI tent staking handbook** for detailed information]
- When SEVERE WEATHER is approaching, the TENT SHOULD BE EVACUATED— and TAKEN DOWN!

Proper Setup Note:

Make sure all poles are vertical and form a 'squared up' rectangle. (30 wide and larger: use a *Mason's* string – attach at the base of one corner pole, go around all 4 corners to form a box. Tighten the string – then align all side poles by having them touch the string). Proceed by bringing these poles vertical and applying proper tension to each strap – start at the middle of one of the short sides (2 people, same speed) and work around the tent, ending with the middle of the other short side (see figure E). **The person on the 'wind side' goes first.** Lastly, re-check the corner poles.

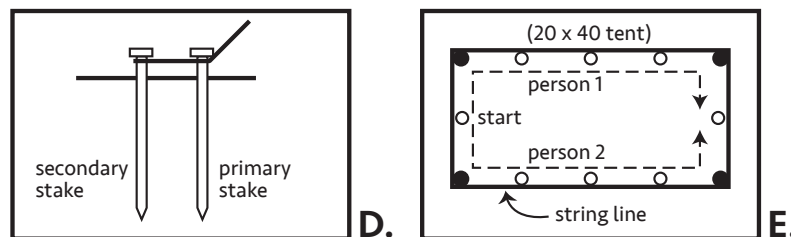
**RAIN!**

When rainwater collects on the tent canopy it causes 'ponding'— occurring in heavy weather conditions. If the tent is not tensioned correctly, this issue will be made worse. Additional weight from the water will cause the tent to sag – this may cause the poles and base plates to sink into the soil. In addition, water saturated soil will cause the stakes to lose their holding power. When you combine loosened stakes, added weight on the canopy and reduced tension on ratchet assemblies, the structure becomes a **safety hazard**. IT IS THE TENT OWNERS RESPONSIBILITY TO ASSURE THE SAFETY OF ALL INVOLVED.

SNOW WARNING: As weather can be unpredictable, the installer/end user must incorporate sound judgment regarding weather conditions. The owner is responsible for anticipating weather severity for safe usage. We do not recommend leaving our *event tents* set up in windy or adverse weather conditions. **Do not allow WATER or SNOW to accumulate on your tent top**, as this weight can destroy the tent fabric, reduce the holding power of stakes, or **collapse the tent**. Tents, canopies and temporary shelters are not designed to carry any type of snow load. These products should not be used if snow of any kind is present, and must be evacuated immediately.

STRIKE PROCEDURE (basically, reverse order from assembly)

- 1.) Undo ratchet strap assemblies/untie ropes
- 2.) Unfasten spring buckle straps, under canopy
- 3.) Remove leg poles, on one long side
(use tent jacks for larger tents)
- 4.) Remove adjacent center, leg poles, on short sides
- 5.) Lower first long side to the ground
- 6.) Repeat, remove leg poles, on remaining long side
- 7.) Lower rest of frame to ground
- 8.) Lay tarp next to a long side of frame
- 9.) Loosen canopy corners
- 10.) Slowly slide canopy off frame—flapping, in unison, as you go
- 10.) Fold and bag canopy (dry canopy)
- 11.) Disassemble poles and connectors
- 12.) Remove ground stakes

Folding Canopy:

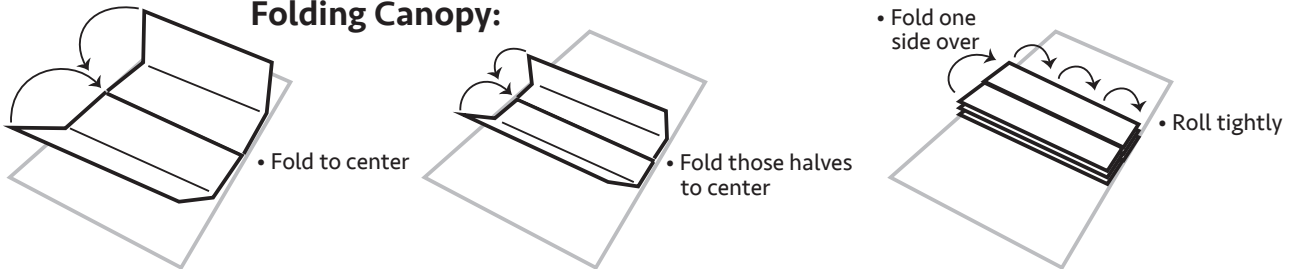

USING RATCHET STRAPS

(Ratchet Buckle Components)

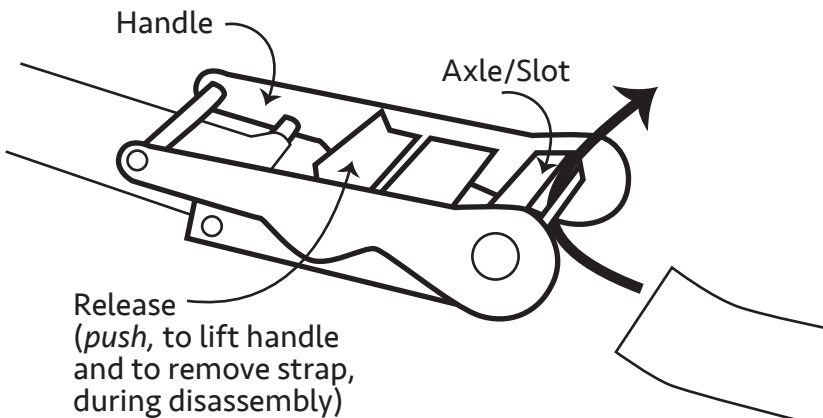

- Release handle, crank until slot is pointing up
- Close handle
- Pass strap underneath and through the slot (as shown)
- While holding the whole strap assembly attach both ends (eg. tent to stake)
- Remove slack, before tightening
- Push 'release'— lift handle and tighten ratchet
- Roll-up any excess strap, put under handle
- Close handle

Appendix A.

- Tent Plan— showing details (spreader/rafter reference below)

10X30 TENT (10x20 with mid-kit)

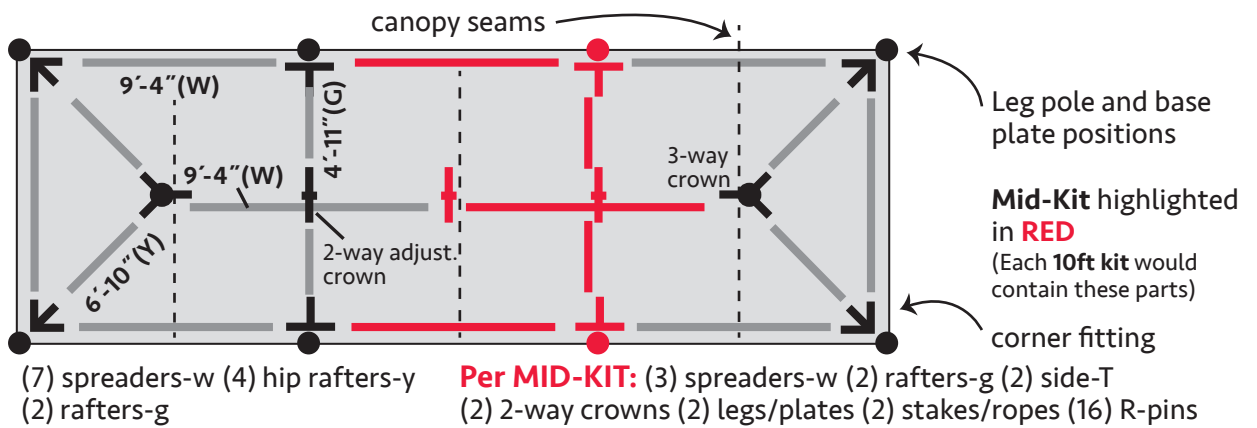

20X50 TENT (20x40 with mid-kit)

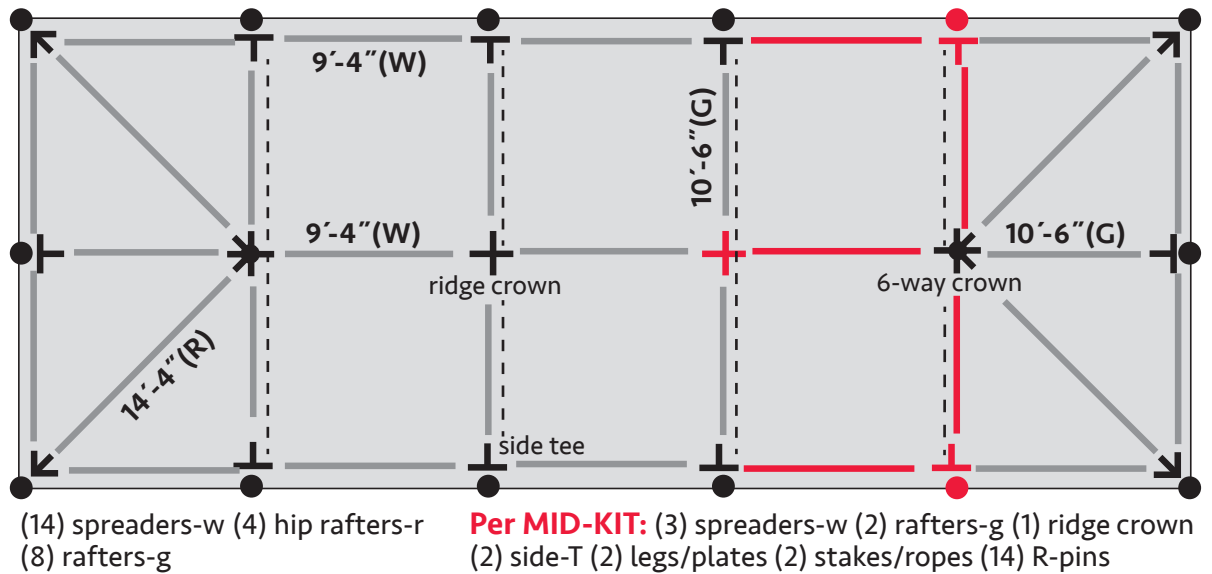

10ft. WIDE

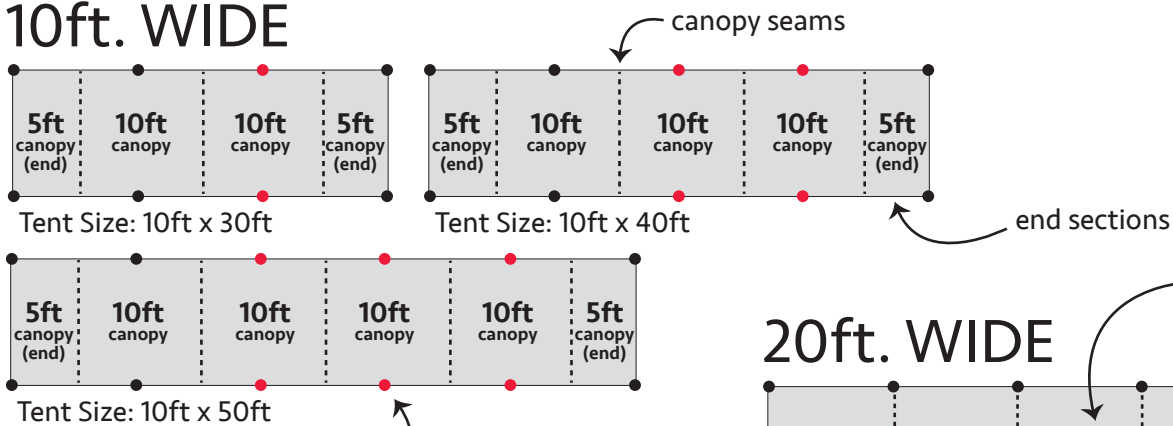

These examples illustrate how the **Sectional Canopies** are put together, for 10w and 20w— Several tent lengths can be made using these guidelines

Mid-Kit legs highlighted in RED

20ft. WIDE

