

SINGLE TUBE	SINGLE TUBE
30'x30'	40'x40'
30'x45'	40'x60'
30'x60'	40'x80'
30'x75'	40'x100'

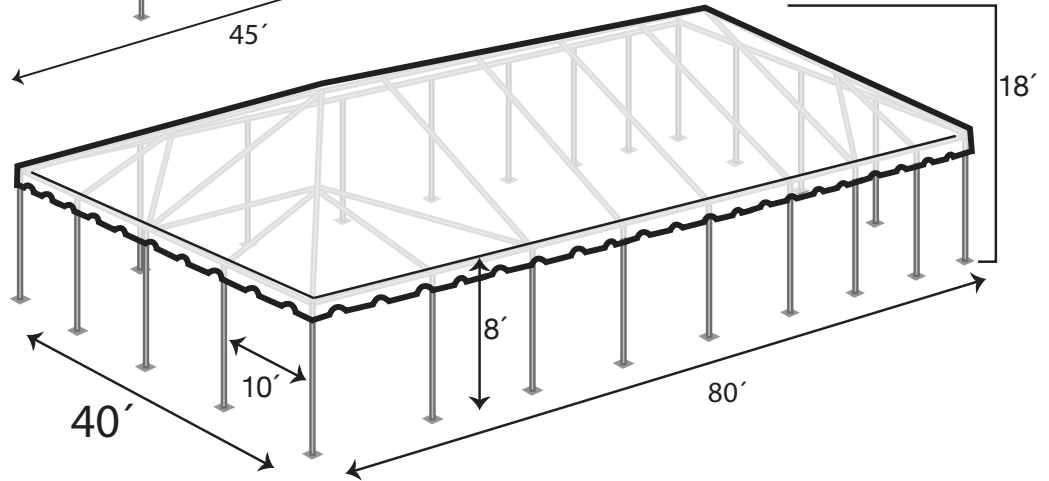

WEST COAST FRAME TENTS

30' & 40' wide

ASSEMBLY INSTRUCTIONS



WEST COAST TENT OVERVIEW (single tube)

West Coast designed tents have unique frame work, with no center poles. This tent features stronger tubes, fewer parts which makes for faster set-up. It's worth pointing out fewer parts means; less load, less to assemble, faster set-up and faster strike time. For investment purposes, the frames are expandable. With the purchase of an extension kit(s) you can easily make a second, larger tent— a 30ft. long tent can be easily lengthened to 60ft. Take a look here at the basic design.

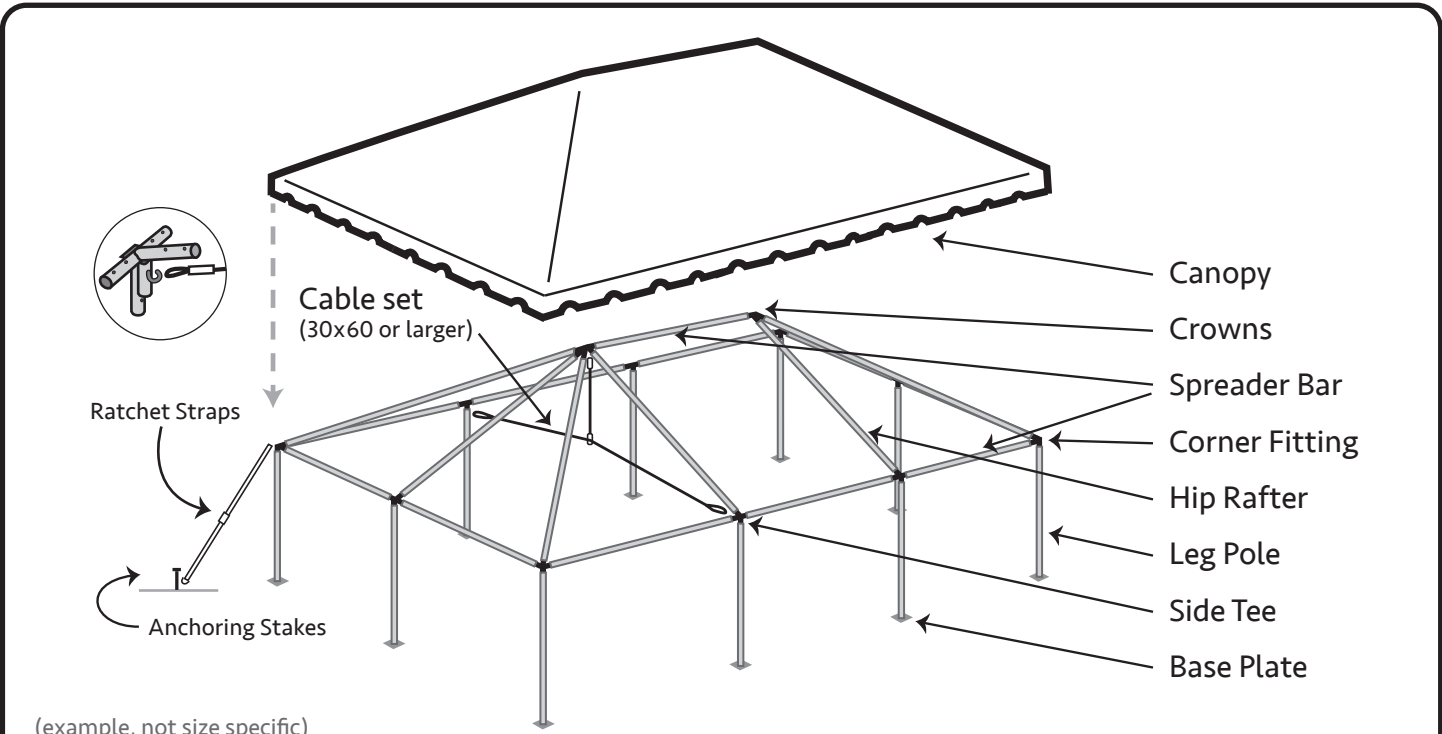



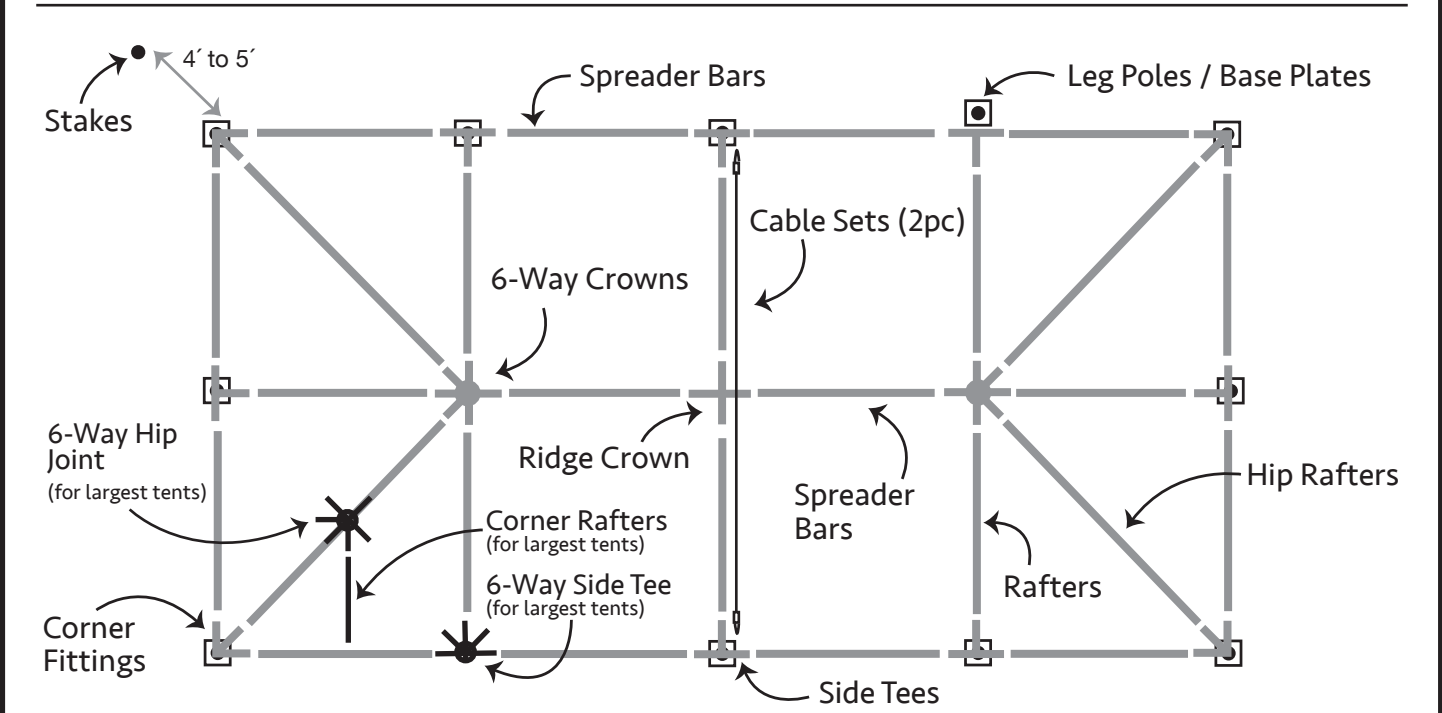





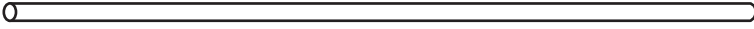

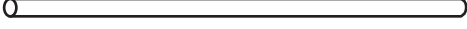

(example, not size specific)

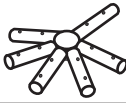
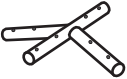



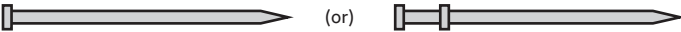

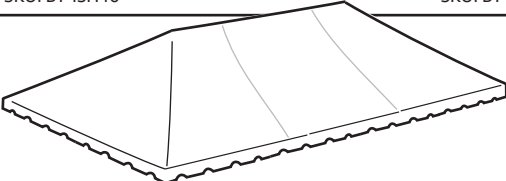

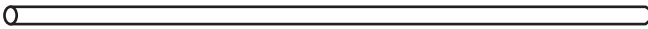
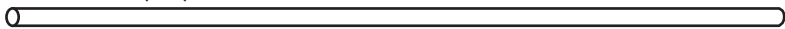

Refer to (appendix) for specific spreader, rafter and fitting layout

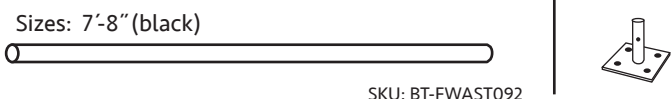
STEP 1. ITEM LIST (30 ft. wide tents/ single tube)

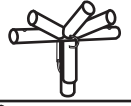
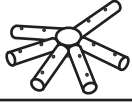
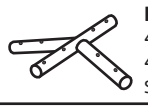
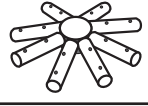
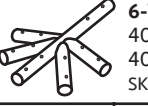
Item	Illustration (all parts available for replacement)	Size	Quantity
Hip Rafters (yellow/red)	Size: 21'-10" (red)  SKU: BT-FWAST262	30x30 30x45 30x60	4 4 4
Rafters (green/red)	Size: 16'-1" (green)  SKU: BT-FWAST193	30x30 30x45 30x60 30x75	4 6 8 10
Corner Rafters (green)		30x30 30x45 30x60	- - -
Spreaders (white/red)	Size: 14'-4" (red)  SKU: BT-FWAST172	30x30 30x45 30x60 30x75	8 11 14 17
Leg Poles / Base Plates (black)	Sizes: 6'-8" (brown)  SKU: BT-FWAST080  SKU: BT-FWBP	30x30 30x45 30x60 30x75	8 10 12 14
Corner Fittings	 SKU: BT-FWCRN-H	30x30 30x45 30x60	4 4 4
Side Tee Fittings	 SKU: BT-FW4WST-H	30x30 30x45 30x60 30x75	4 6 8 10
6-Way Side Tees		30x30 30x45 30x60	- - -
6-Way Crowns	 SKU: BT-FW6WC	30x30 30x45 30x60	- 2 2
(Crowns)	 RIDGE CROWNS 30x60 (1) / 30x75 (2) SKU: BT-FWTTRC	 8-WAY CROWNS 30x30 (1) SKU: BT-FW8WC	
Cross Cables (2pc)	 SKU: BT-FW30CS	30x30 30x45 30x60 30x75	- - 3 4
Loop Ratchet Strap Assembly, w/ ring	 SKU: BT-TARS1-2	30x30 30x45 30x60 30x75	8 10 12 14
'R' Pins	 SKU: BT-FWWWRP50	30x30 30x45 30x60 30x75	48 62 76 90
Single Head Stakes (1" x 40")	 (or)  SKU: BT-1SH40 SKU: BT-118DH40 (11/8X40 IN.)	30x30 30x45 30x60 30x75	8 10 12 14
Canopy Top (sectional)		All sizes-	1
		(see appendix for more info)	

STEP 1. ITEM LIST Cont. (40ft. wide tents/ single tube)

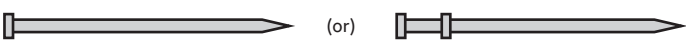
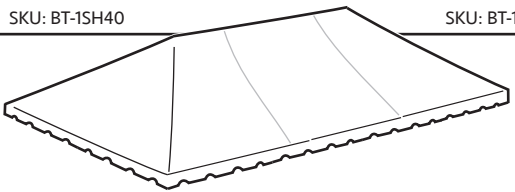
Item	Illustration (all parts available for replacement)	Size	Quantity	
Hip Rafters (yellow/red)	Size: 14'-4" (red)  SKU: BT-FWAST172	40x40	16	
		40x60	16	
		40x80	16	
		40x100	16	
Rafters (green/red)	Size: 21'-10" (red)  SKU: BT-FWAST262	40x40	4	
		40x60	8	
		40x80	12	
		40x100	16	
Corner Rafters (green)	Size: 10'-6" (green)  SKU: BT-FWAST126	40x40	8	
		40x60	8	
		40x80	8	
		40x100	8	
Spreaders (white/red)	Size: 9'-4" (white)  SKU: BT-FWAST112	40x40	16	
		40x60	22	
		40x80	28	
		40x100	34	
Leg Poles / Base Plates (black)	Sizes: 7'-8" (black)  SKU: BT-FWAST092	40x40	16	
		40x60	20	
		40x80	24	
		40x100	28	
Corner Fittings	 SKU: BT-FWCRN-H	40x40	4	
		40x60	4	
		40x80	4	
		40x100	4	
Side Tee Fittings	 SKU: BT-FW4WST-H	40x40	8	
		40x60	10	
		40x80	14	
		40x100	18	
6-Way Side Tees	 SKU: BT-FW6WST-H	40x40	4	
		40x60	6	
		40x80	6	
		40x100	6	
6-Way Crowns	 SKU: BT-FW6WC	40x60	2	
		40x80	2	
		40x100	2	
(Crowns)	 RIDGE CROWNS 40x60 (1), 40x80 (3), 40x100 (5) SKU: BT-FWTTRC	 8-WAY CROWNS 40x40 (1) SKU: BT-FW8WC	 6-WAY HIP JOINT 40x40 (4), 40x60 (4), 40x80 (4), 40x100 (4) SKU: BT-FWTT6WHJ	
Cross Cables (2pc)	 SKU: BT-FW40CS	40x40	2	
		40x60	3	
		40x80	5	
		40x100	7	
Loop Ratchet Strap Assembly, w/ ring	 SKU: BT-TARS1-2	40x40	16	
		40x60	20	
		40x80	24	
		40x100	28	
'R' Pins	 SKU: BT-FWWRP50	40x40	132	
		40x60	152	
		40x80	180	
		40x100	208	
Single Head Stakes (1" x 40")	 (or)	40x40	16	
		40x60	20	
		40x80	24	
		40x100	28	
Canopy Top (sectional)		All sizes-	1	
		(see appendix for more info)		

STEP 1. CONTINUED

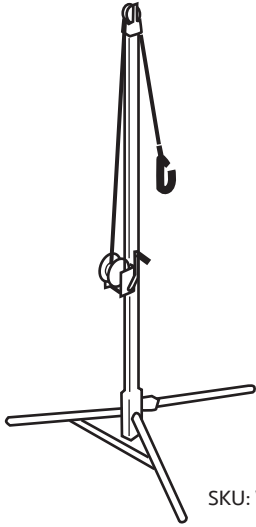

SKU: WCF-JACK-12

This item is very important in the process, Frame Tent Jack (sold separately). Most West Coast Frame tents require *frame tent jacks*—and larger tents require multiple jacks.

General rules are; work on the long side, one side at a time, and never place jack in the middle of a spreader bar.

(set-up and use can be found on internet)

Tent Size	Estimated Quantity
30 x 30	2
30 x 45	3
30 x 60	4
30 x 75	4
40 x 40	3
40 x 60	4
40 x 80	5
40 x 100	6

Recommended Tools

6ft. step ladders
Sledge Hammer
Tape Measure

Stake Driver
(for larger tents)

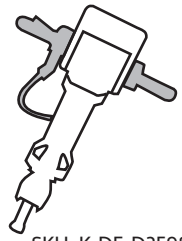

SKU: K-DE-D25980K

WARNING

Tent products are manufactured for use as temporary structure and do not meet structural code, unless specified. Since weather is unpredictable, the customer must incorporate their own good judgment, common sense & knowledge of local conditions with the installation instruction guidelines.

The customer is responsible to anticipate weather severity for proper time and method of construction.

'BEFORE YOU DIG' (hammer stakes)

By Law you are required to contact your local "Call before you dig" number before you plan to dig. After calling, your local utility company will mark the location of underground utility lines. Laws from state to state vary on how far in advance you must call.

Planning ahead and checking with your state's program is always a smart idea. Failure to obtain a line location before digging can result in a substantial fine. Please find your local "call before your dig number" by going to call811.com.

STEP 2. SAFETY CHECK LIST



- When building or assembling anything above shoulder height, wear a hard hat
- Steel toe boots are recommended
- Inspect the site, look for overhead and underground obstructions— such as utilities
- Call your local utility to have utility lines marked (call 3–5 days ahead)— call811.com is a good resource— 'click' 811 in Your State
- Inspect all ropes and tie lines
- Inspect poles, making sure there are no bends or breaks
- Replace or repair any items in poor condition

STEP 3. LAYOUT FRAME

Position parts in the exact location of finished tent

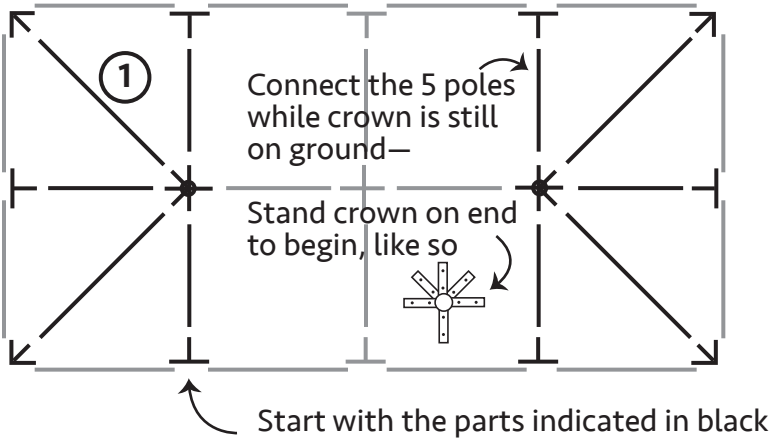

- Place all metal poles and fittings on the ground in the location you have selected for the finished tent
- This layout illustrates a 30 x 60 tent — see (**appendix A/B/C/D**) for your specific size, layout and pole sizes
- 1) Start with the crown and its connecting poles—the drawing shows the correct position of the crown—secure these parts using (2) 'R' pins per pole
- See (**figure A.**) for 'R' pin usage
- Stand these two *end* assemblies up, to connect the ridge parts next

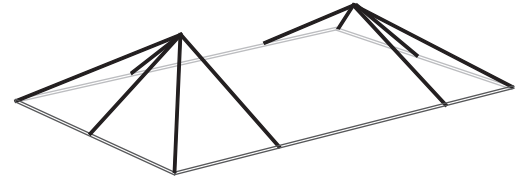
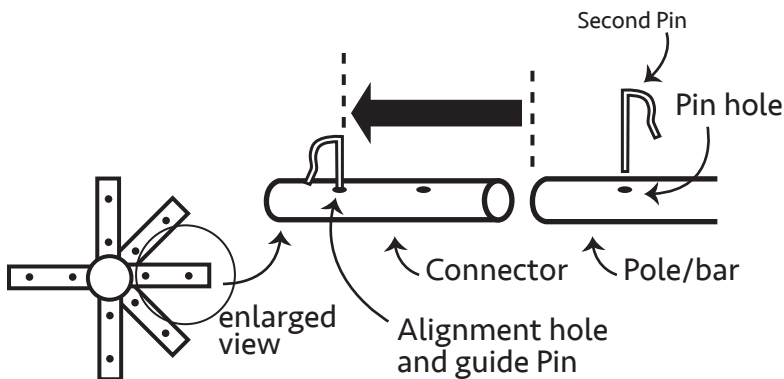

FIGURE A. 'R' PIN AND ALIGNMENT HOLE



- All connection will be made using this method—2 pins needed
- Insert a pin, halfway, into the alignment hole—this will act as *stop*, for spreader and rafter bars
- Slide pole (spreader, rafter etc.), onto the appropriate connector—touch the *alignment pin*, as a guide
- The pin holes are now lined up—insert the second 'R' pin, all the way, until it locks in place

Reminder:

Frame plans and connector positions, for your tent, appear in the appendix

STEP 4. RIDGE AND PERIMETER

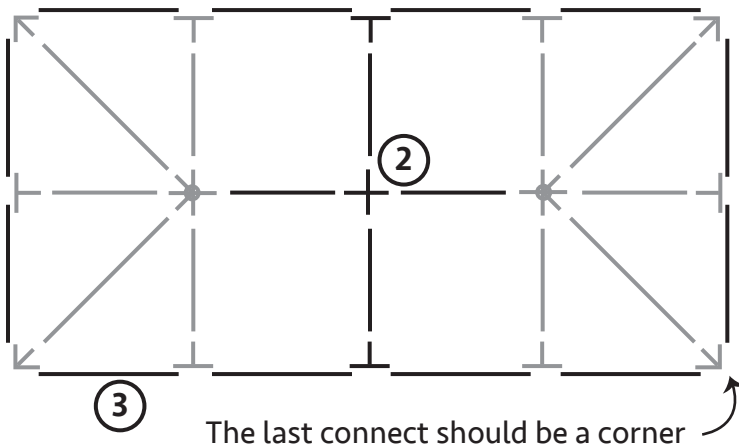

- 2) Connect the ridge line next, crowns and spreaders
- While standing on a ladder(s) make all connections from end to end
- If you are short of people, use a tent jack to hold horizontal poles
- 3) Lastly, connect all perimeter bars to the upper spreaders and rafter bars
- When working around the perimeter, the last connection should be at a corner, *not* a side tee
- The frame should now be complete

STEP 5. CROSS CABLES

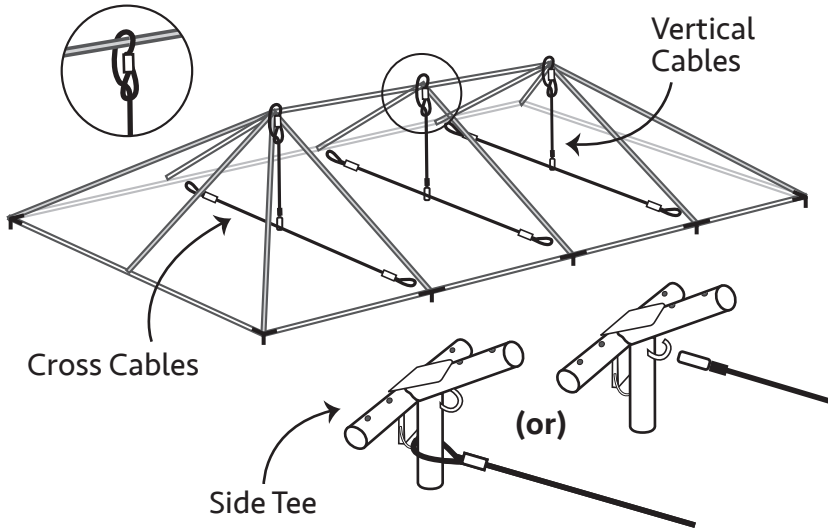

- While the frame is still on the ground slide the cross cables on the side tees (only for tents 30x60 and larger)—the leg poles will help to keep cables in place
- Each tent has a specific number of cables see (appendix) for your layout
- Side tees, for larger tents, have metal loops built on them—to accommodate different style cables
- Attach cable to hooks, directly opposite each other, *as shown*
- The vertical cables are part of the cable assembly—attach them from crown to cross cable

STEP 6. RATCHET STRAPS OR ROPES

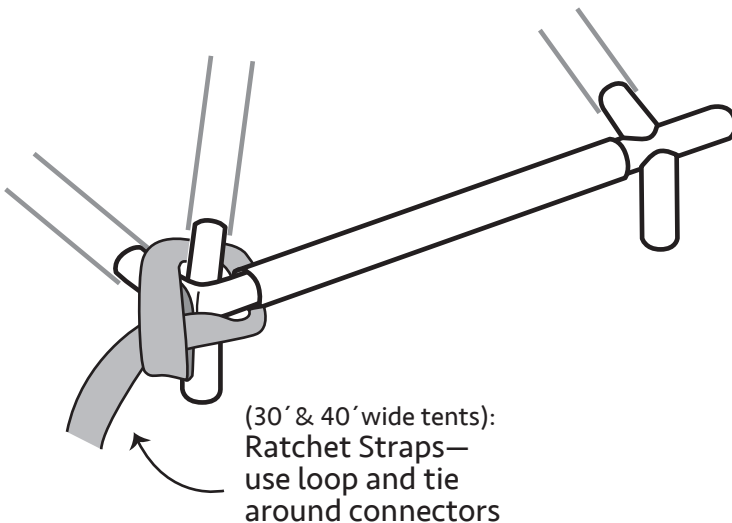

- While frame is still on the ground, tie ratchet straps/ropes to frame
- The straps/ropes will be secured to the tent stakes at the end of the assembly
- One strap/rope per leg pole
- The straps/ropes go under and over, to prevent the them from sliding—see (**drawing**)

Note: this step can occur after the leg poles have been installed and the frame is elevated

Note: some twin tube fittings have metal rings, to connect ratchet straps

FIGURE B. COMPLETED FRAME

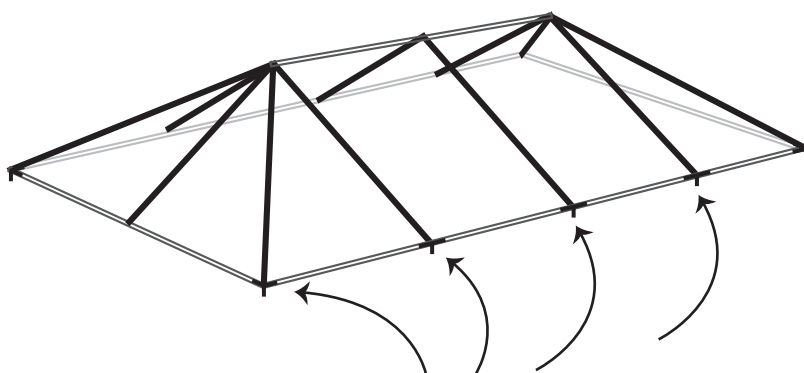

If repositioning is necessary, try to have one person lift at each fitting, all the way around

- Now that the frame portion is complete and while the frame is still on the ground, double check the 'R'-pins
- Also, with plenty of hands on deck, lift and adjust frame position if needed, at this point— see (**figure B**)
- Always lift at a side or corner fittings

STEP 7. CANOPY

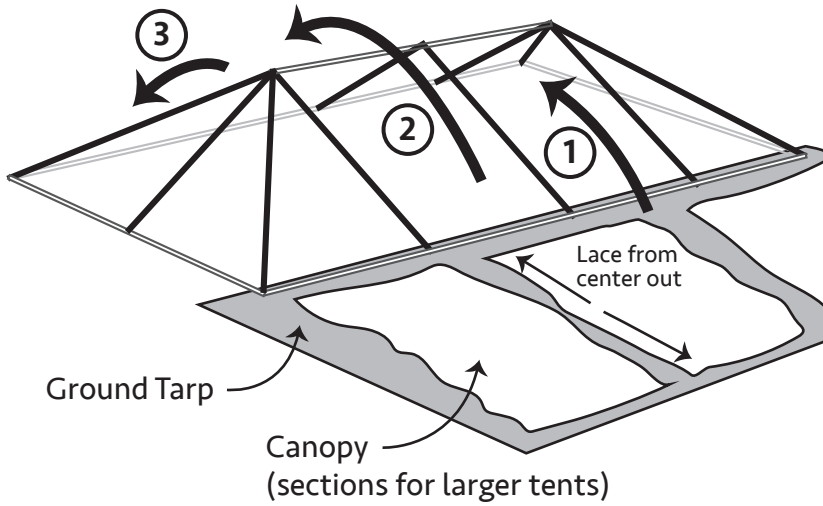

- Once again, while frame is still on the ground, lay down a tarp(s), to protect canopy—arrange canopy along one of the long sides of the tent
 - Most large tents will need to have canopy sections laced together, first—see (figure C)
 - Place a ladder(s) next to ridge spreaders —as many as it takes to easily to pull canopy over ridge
 - One person needed for every 10ft of tent
- 1) In unison, pull canopy up one side—'flapping' in the beginning, to create lift —then stop
 - 2) 2 to 4 people stay on the ground, others on the ladders—pull canopy over the ridge
 - 3) Pull down the other side—'flapping' for all three steps

FIGURE C.

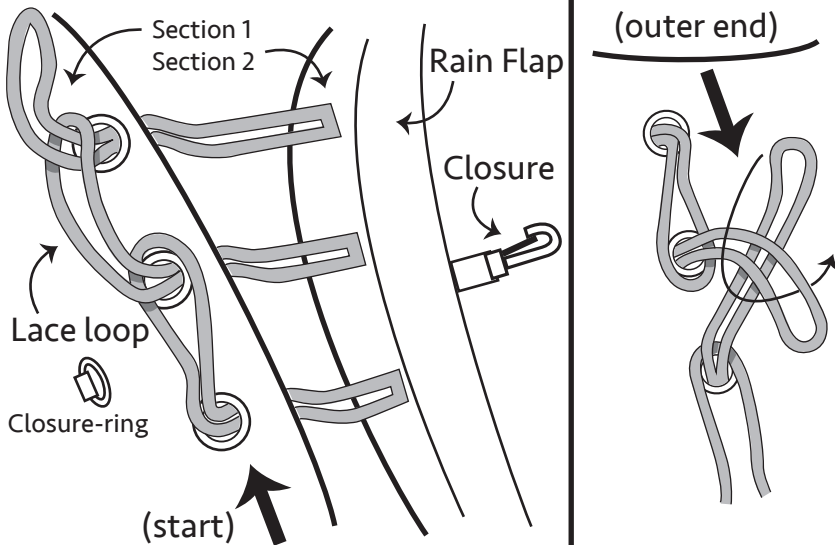

- Starting at **center** of canopy, push first loop through corresponding grommet
- Second loop passes through grommet and first loop—continue with this way
- DO NOT walk on canopy
- Continue lacing the loops—pull tight at every loop, as you go
- Snap the closures and close rain flap as you progress outward
- When you get toward the *outer end*, lace the last two or three loops backwards and tie off the connecting loops
- Last, attach sections using ring and clip

STEP 8. CANOPY CORNERS

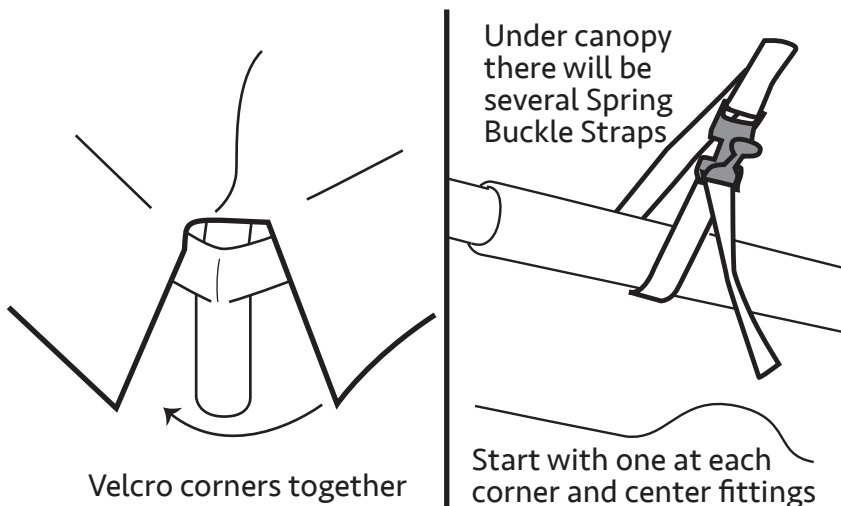

- After canopy is pulled over frame and corners are pulled into position, velcro corner seams together, loosely—tighten after legs are installed
- The canopy should be attached to the frame, after leg poles are installed—secure some of the spring buckle straps so, any high wind won't cause issues during the raising process
- Spring buckle straps are located on the underside of canopy
- Secure the remaining straps after one side have legs installed and secure—it's easier at this height—Final tightening happens after legs are installed (**step 10**)

STEP 9. BASE PLATES

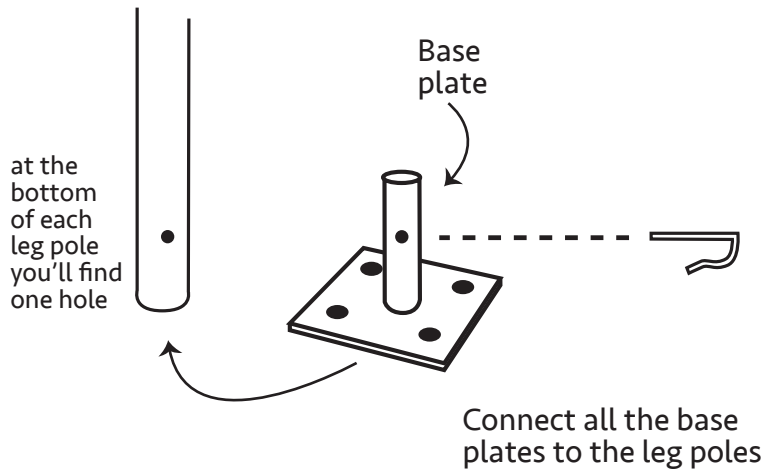

- Before the tent is raised, prepare the leg poles
- Place poles on top of base plate and secure with 'R' pins
- Do this for all the leg poles

Note: some legs have adjustable heights, be aware— select the same pin hole when attaching base plates

STEP 10. INSTALLING LEGS (15x30 and larger tents)

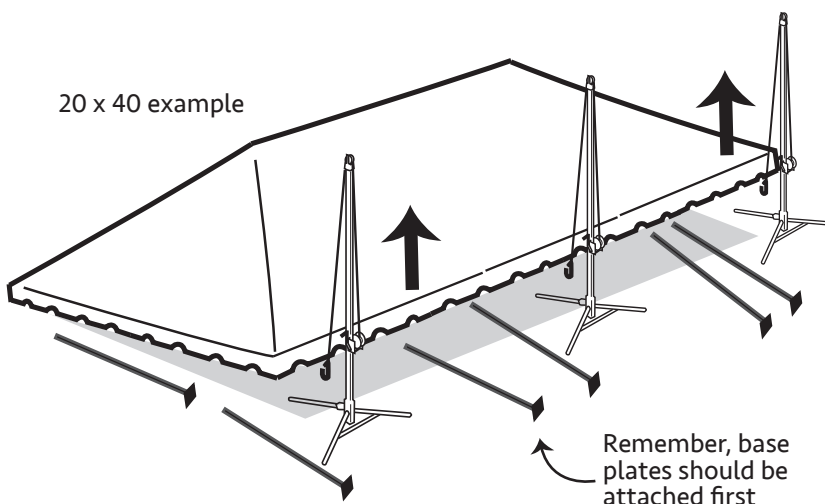

- For larger tents, (30x30 and larger) frame tent jacks should be used to raise the frame and install the leg poles
 - Locate one of the long sides of the frame—this will be raised first, while the opposite side remains on the ground
 - **Important:** Lift the entire side of the frame at once (not one corner)—crank jacks in unison
- General rules are; work on the long side, one side at a time, and **never** place jack in the middle of a spreader bar*
- Install all the legs on this side—secure with 'R' pins
 - Repeat for opposite side, then install legs for the remaining two sides
 - **Important:** tighten spring buckle straps—for security and to help pull canopy corners into place

STEP 11. STAKE LINE

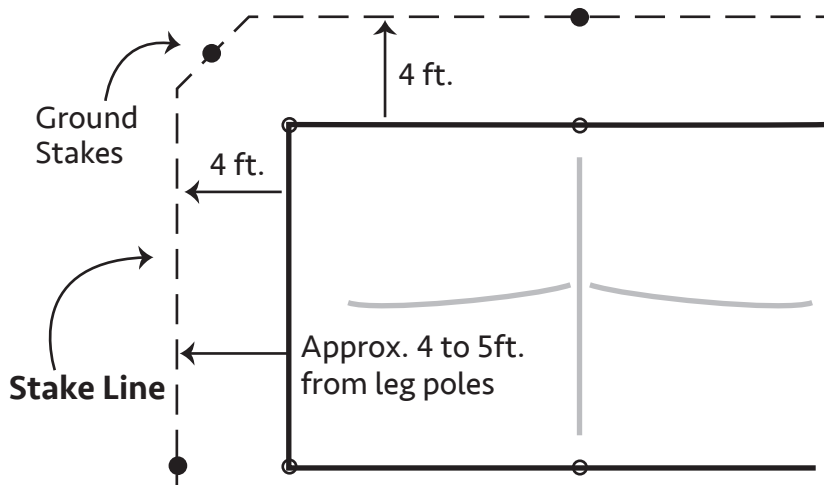

Double check leg poles—making sure each pole is straight and lined up correctly, while tent jacks are still handy

- Once the tent is vertical and all the leg poles are attached, begin the process of staking the tent—with plenty of hands on deck, lift and adjust tent position if needed, first
- Measure 4 ft. out from each leg pole and place a stake in the ground
- Slide stakes through ratchet straps, before stakes go in the ground—see **(figure C)**
- Stakes should then be hand hammered or for larger installs, use a stake driver

FIGURE C. HAMMERING STAKES

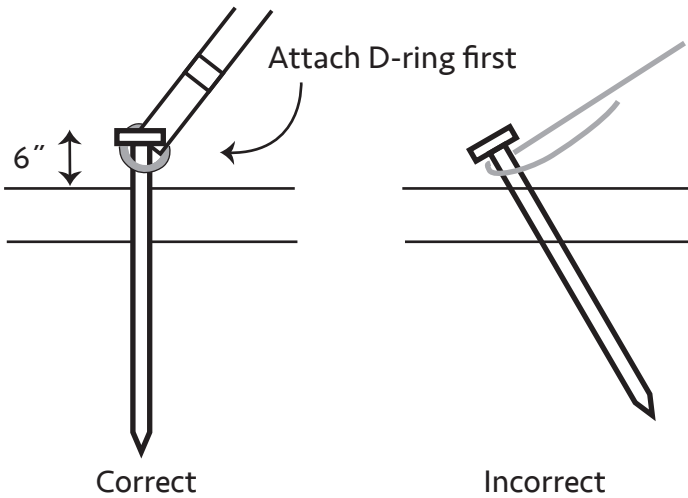

- Ground stakes should be hammered in vertical, not angled (sledge hammer required)
- Check connection of 1" ratchet strap, from frame to ground stake, before stakes go in the ground—slide stake through 'D-ring'
- Complete the hammering process by driving the stakes in and leaving 6 inches showing

(Stake Note: to expedite tent orders we include *available* stakes— this could be 40" single or double head option)

Note: Using the ratchet strap (buckle) can be found on (**page 9**)

STEP 12. SECURING RATCHET STRAPS

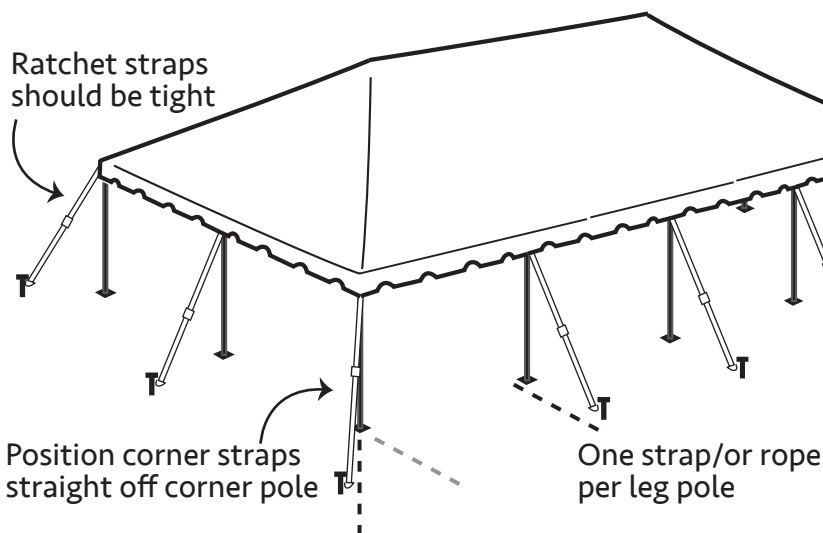

- As the assembly nears completion it is time to tighten all ratchet straps/ropes
- Push the release lever on the buckle and remove excess slack, then crank the handle to tighten strap assembly—keep an eye any lean that might be caused
- Go around the tent, make adjustments for any leg pole and tent lean
- Finally, double check and tighten spring buckle straps, under the canopy, that were not secured in step 10

FINISHED TENT

30 x 60 example

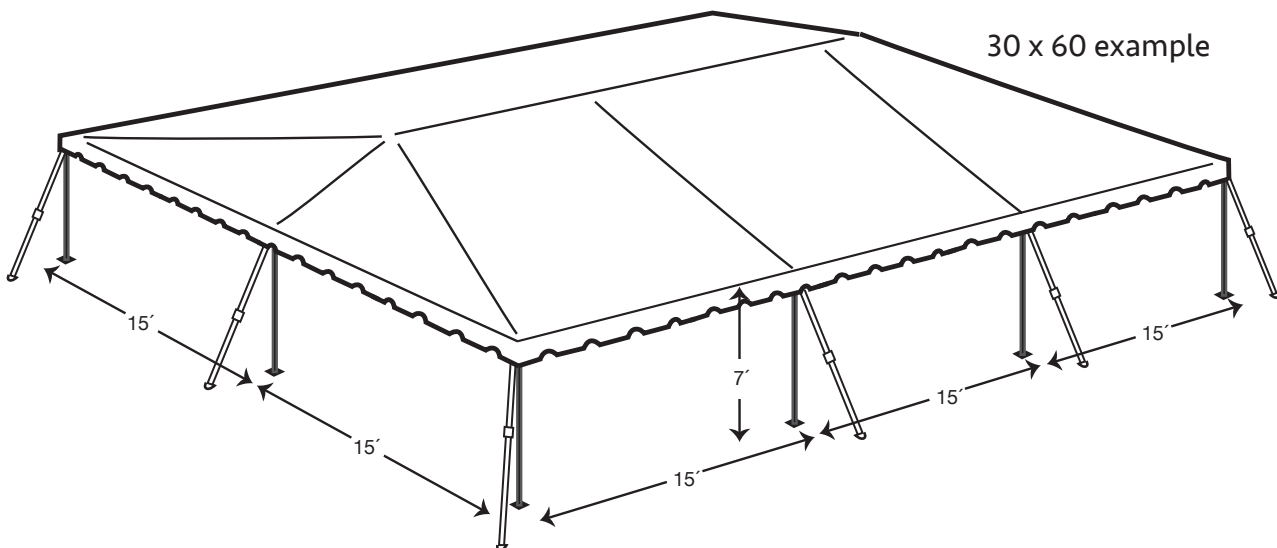

WIND AND RAIN – IMPORTANT INFORMATION:

WIND!

Wind can cause the ratchet assemblies and stakes to loosen, or cause the poles to **sink** or shift through constant movement and vibration – the tension of the tent will be negatively altered.

Follow these steps to provide extra security and safety during windy conditions:

- Very important, do routine maintenance checks – be sure to check proper tension regarding the ratchet assemblies, throughout the day/event. This is critical, if your tent must stay up, in moderate windy conditions.
- In the case of strong winds, remove any sidewalls. This will allow the wind to pass through the tent, diminishing major upward pressure on the tent top.
- Additional security can be achieved by adding additional stakes and ropes/straps to corners— and to the 'wind side' of the tent.
- When anticipating windy conditions, perform a **soil test** to determine proper staking:
 - 1.) drive a large steel stake approx. 20 in. into soil, vertically
 - 2.) measure the distance from the ground to the top of stake
 - 3.) with a 16lb. sledge hammer, strike stake with an average blow (don't over hit)
 - 4.) measure the **movement**/hold strength: (**0.2in./2500lbs**) (**0.3-.5in./1600lbs**) (**0.6-1.5in./800lbs**) (**1.6-3in./400lbs**) (**3-6in./200lbs**) (**> 6in./100lbs**) Double or triple staking might be necessary, 10in. behind primary stake (see figure D). [search web for: tent.IFAI tent staking handbook for detailed information]
- When SEVERE WEATHER is approaching, the TENT SHOULD BE EVACUATED— and TAKEN DOWN!

• Proper Setup Note:

Make sure all poles are vertical and form a 'squared up' rectangle.

30 wide and larger: use a *Mason's string* – attach at the base of one corner pole, go around all 4 corners to form a box. Tighten the string – then align all side poles by having them touch the string. Proceed by bringing these poles vertical and applying proper tension to each strap – start at the middle of one of the short sides (2 people, same speed) and work around the tent, ending with the middle of the other short side (see figure E). **The person on the 'wind side' goes first.**

Lastly, re-check the corner poles.

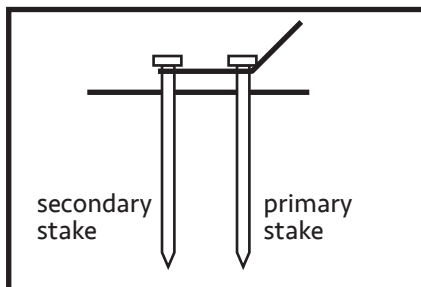

D.

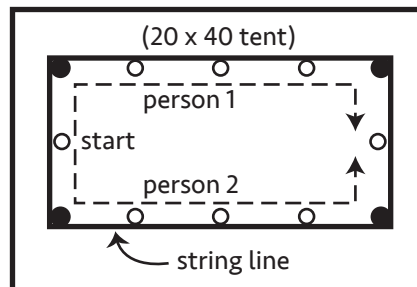

E.

RAIN!

When rainwater collects on the tent canopy it causes 'ponding'— occurring in heavy weather conditions. If the tent is not tensioned correctly, this issue will be made worse. Additional weight from the water will cause the tent to sag – this may cause the poles and base plates to sink into the soil. In addition, water saturated soil will cause the stakes to lose their holding power. When you combine loosened stakes, added weight on the canopy and reduced tension on ratchet assemblies, the structure becomes a **safety hazard**. IT IS THE TENT OWNERS RESPONSIBILITY TO ASSURE THE SAFETY OF ALL INVOLVED.

STRIKE PROCEDURE (basically, reverse order from assembly)

- 1.) Undo ratchet strap assemblies/untie ropes
- 2.) Unfasten spring buckle straps, under canopy
- 3.) Remove leg poles, on one long side
(use tent jacks for larger tents)
- 4.) Remove adjacent center, leg poles, on short sides
- 5.) Lower first long side to the ground
- 6.) Repeat, remove leg poles, on remaining long side
- 7.) Lower rest of frame to ground
- 8.) Lay tarp next to a long side of frame
- 9.) Loosen canopy corners
- 10.) Slowly slide canopy off frame—
flapping, in unison, as you go
- 10.) Fold and bag canopy (dry canopy)
- 11.) Disassemble bars and connectors
- 12.) Remove ground stakes

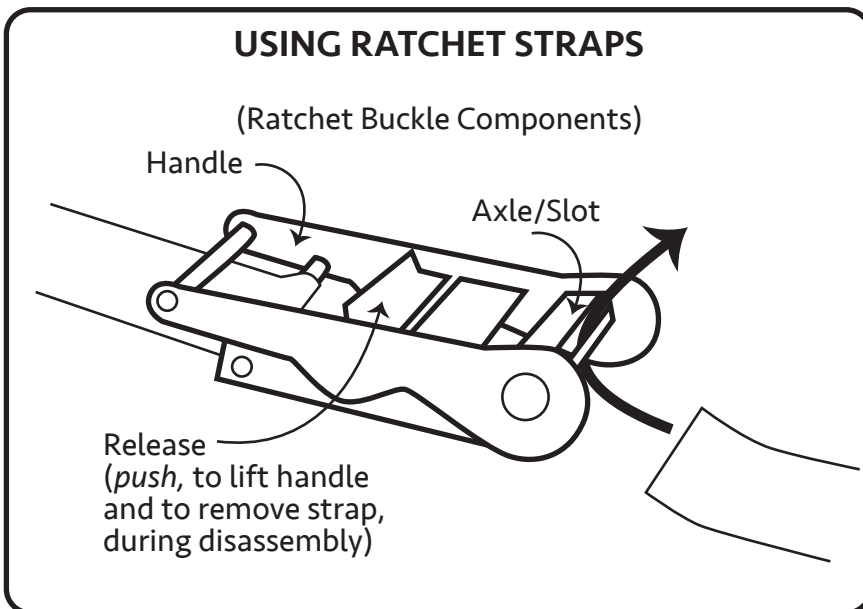
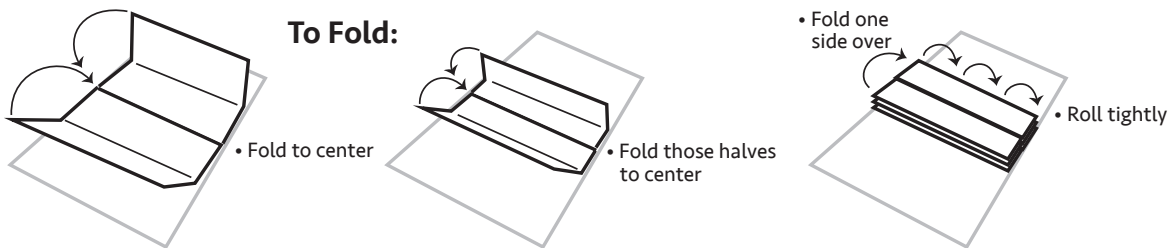

- Release handle, crank until slot is pointing up
- Close handle
- Pass strap underneath and through the slot (as shown)
- While holding the whole strap assembly attach both ends (eg. tent to stake)
- Remove slack, before tightening
- Push 'release'— lift handle and tighten ratchet
- Roll-up any excess strap, put under handle
- Close handle

Appendix A.

- Plans— showing tent sizes, leg pole and connector quantity and locations

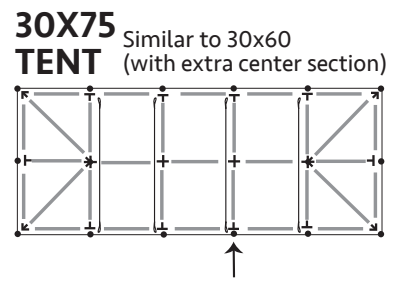
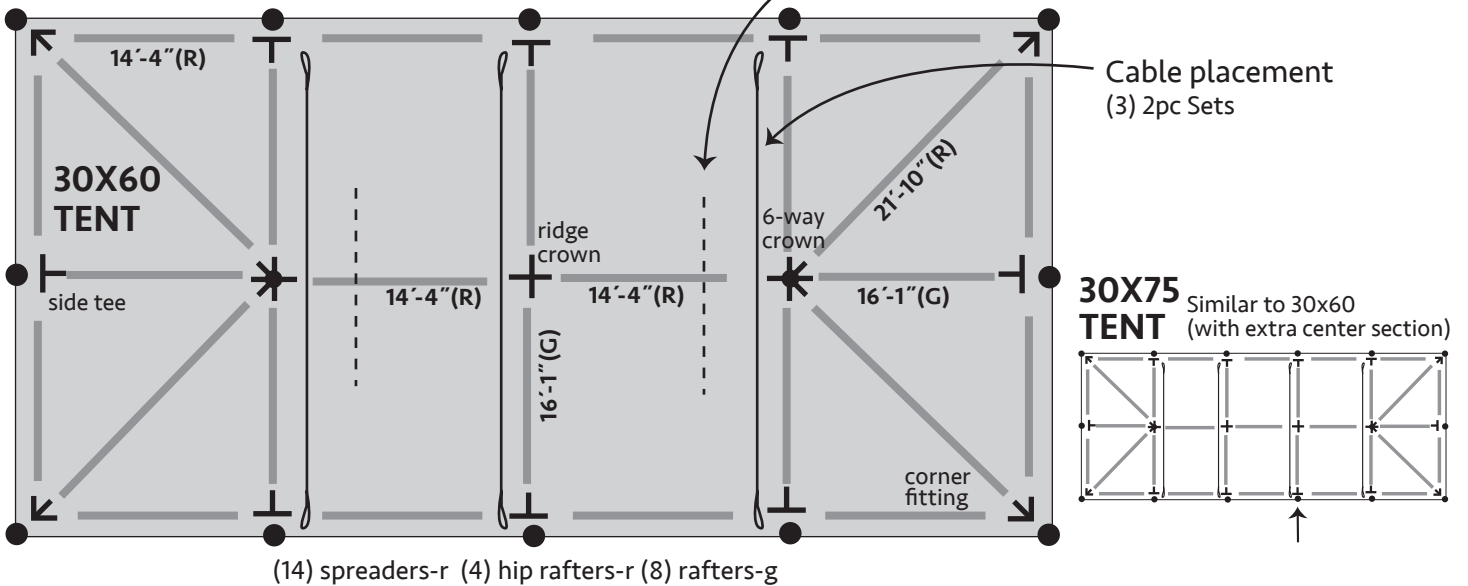
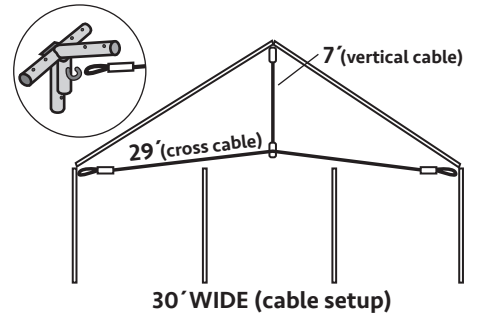
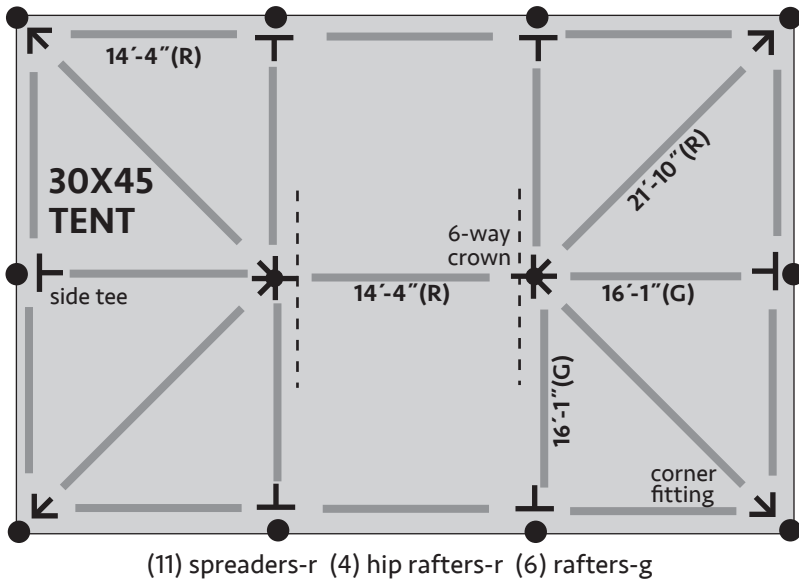
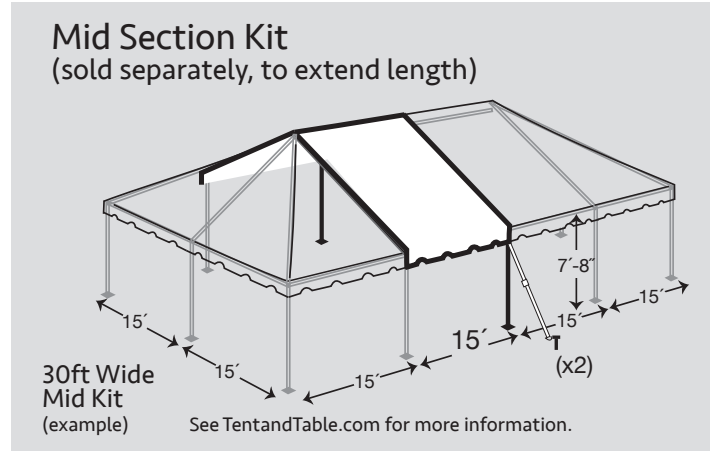
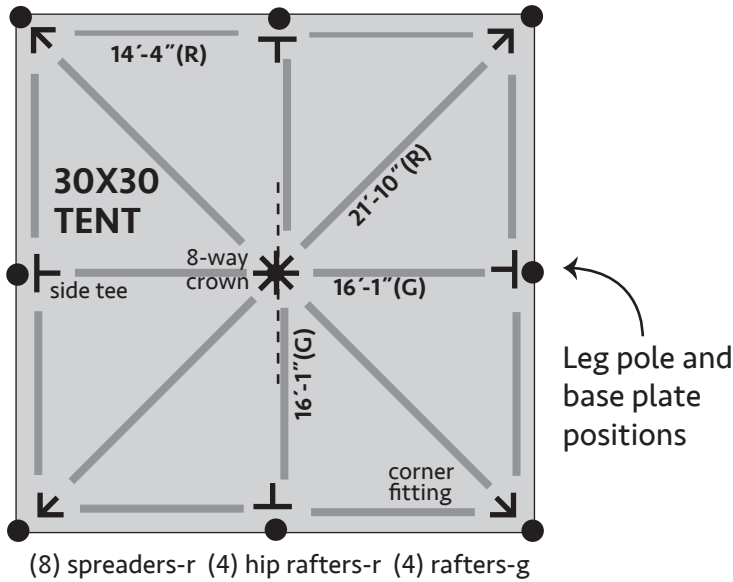

Appendix B.

- Plans— showing tent sizes, leg pole and connector quantity and locations

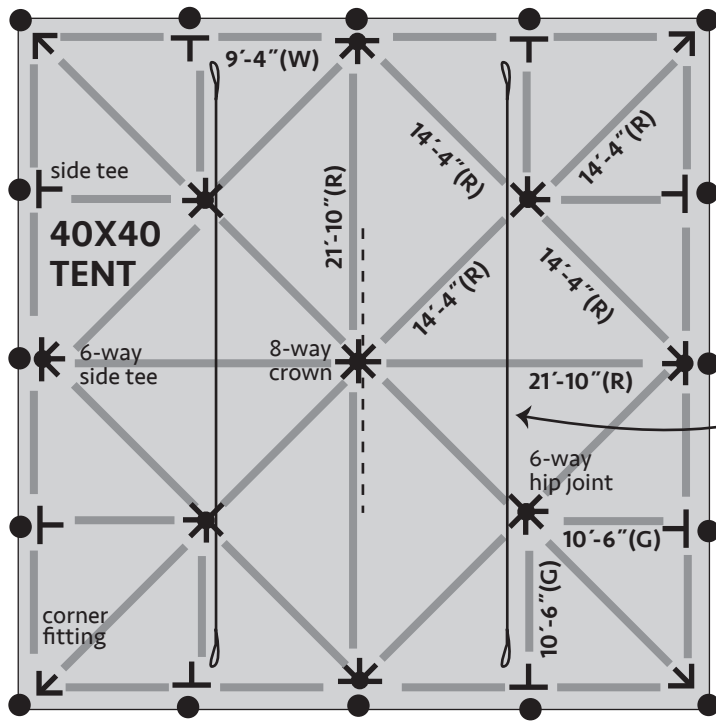

(16) spreaders-w (16) hip rafters-r (8) corner rafters-g (4) rafters-r

Leg pole and base plate positions

Cable placement (1) 2pc Set

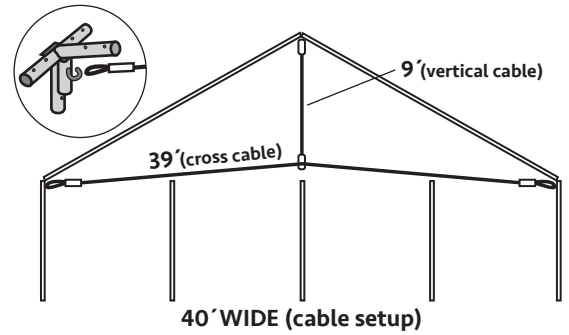

Canopy Section Seams (dotted line)

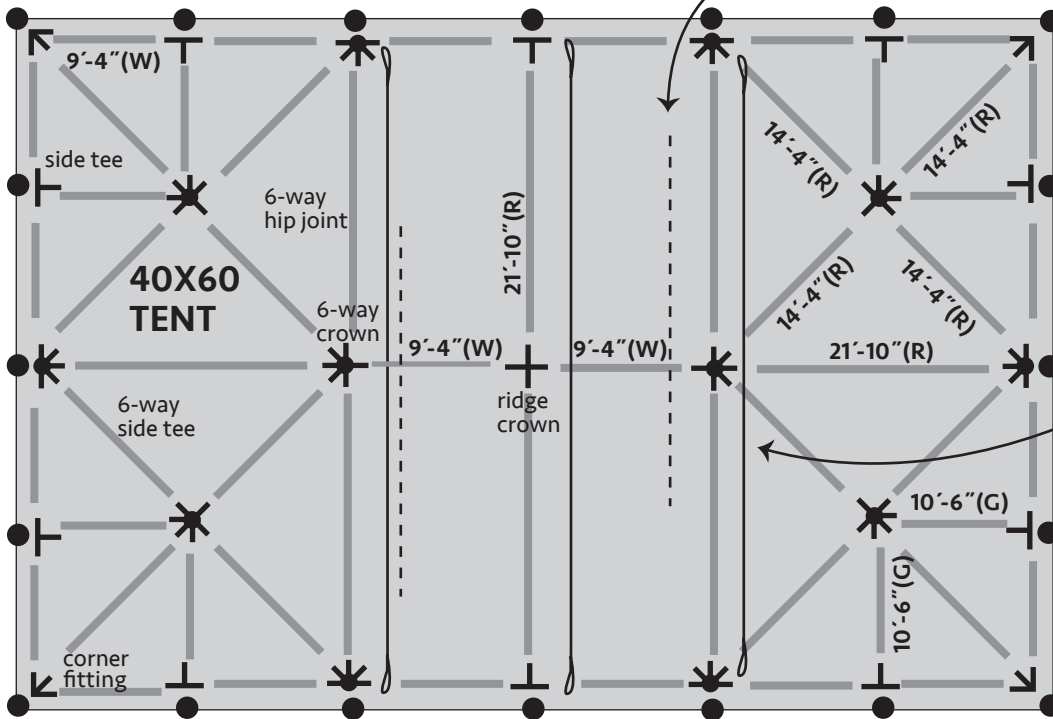

(22) spreaders-w (16) hip rafters-r (8) corner rafters-g (8) rafters-r

Cable placement (3) 2pc Sets

Appendix C.

- Plans— showing tent sizes, leg pole and connector quantity and locations

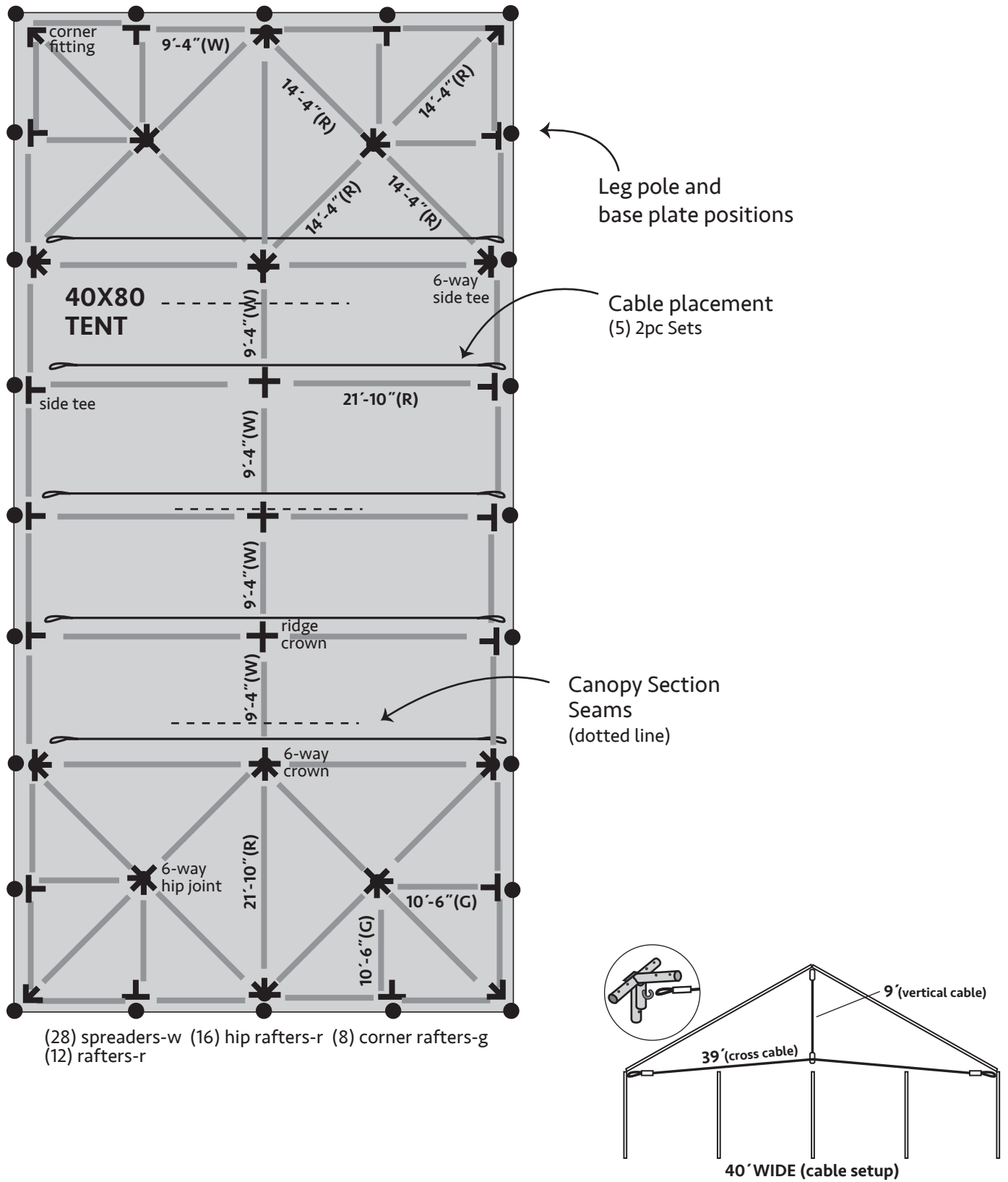

Refer to (page 1) for basic spreader and rafter layout

Appendix D.

- Plans— showing tent sizes, leg pole and connector quantity and locations

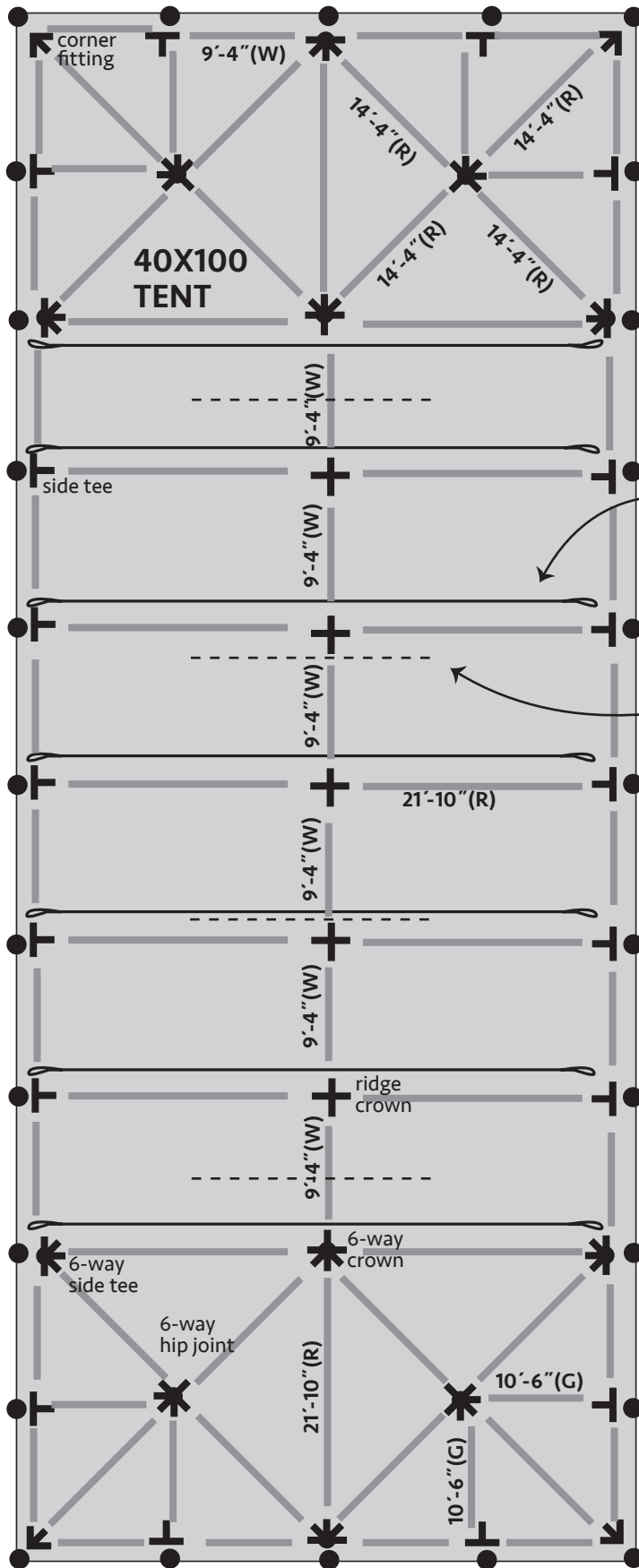

Leg pole and base plate positions

Cable placement (7) 2pc Sets

Canopy Section Seams (dotted line)

(34) spreaders-w (16) hip rafters-r (8) corner rafters-g (16) rafters-r

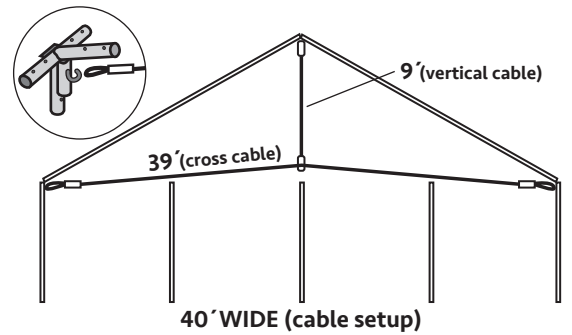

Refer to (page 1) for basic spreader and rafter layout