

## HIGH PEAK FRAME (WEEKENDER)

# 20' x 20'

## ASSEMBLY INSTRUCTIONS



## High Peak Frame- Weekender Tent (OVERVIEW)

**Recommended Tools:**



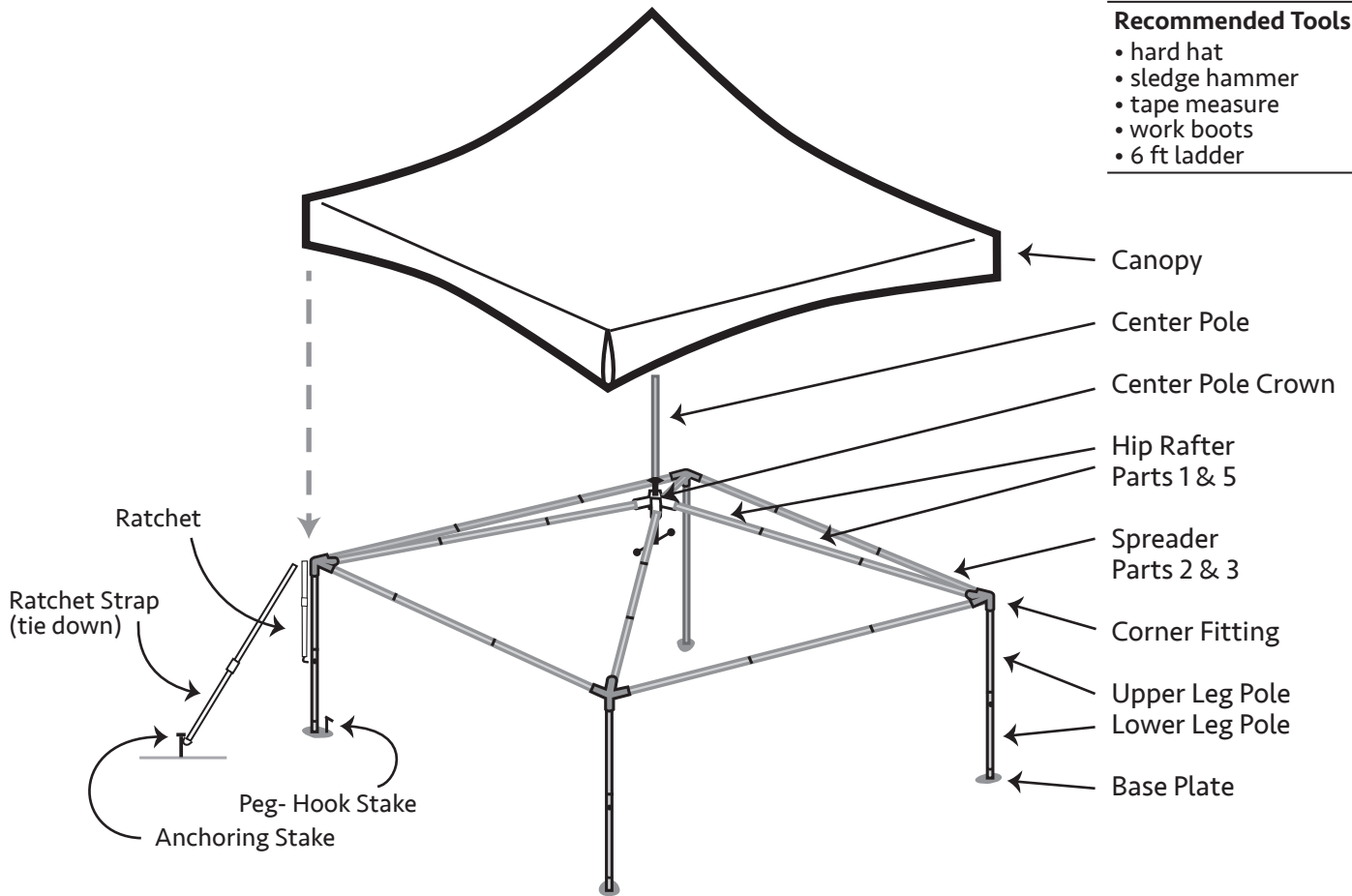





- hard hat
- sledge hammer
- tape measure
- work boots
- 6 ft ladder

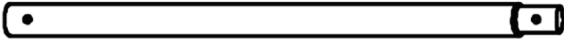
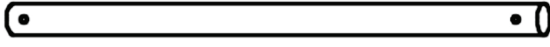
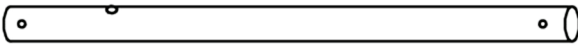
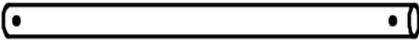
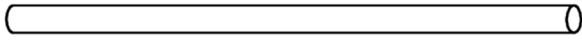
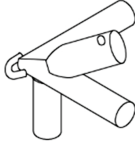
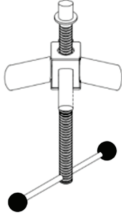
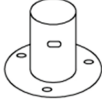

## HPF- Weekender Tent (SPECIFICATIONS: 20x20)

Width	20 ft. / 6.1m	Fabric Material	PVC Coated Polyester
Length	20 ft. / 6.1m	Fabric Material Weight	14 oz. / yd <sup>2</sup> / 480 gsm
Area	400 ft <sup>2</sup> / 37.2m <sup>2</sup>	Fabric Translucency	Yes
Eave Height	8' / 2.4m	Water Repellent	Waterproof
Overall Height	16' 9" / 5.1m	Snow Load	None
Pitch	8' 9" / 2.7m	Flame Resistant	Yes
Complete Weight	326 Lbs. / 148 Kg.	UV Resistant	Yes
Series	High Peak-Weekender	Mold and Mildew Resistant	Yes
Class		Frame / Pole Material	Galvanized Steel
Center Pole	No	Longest Component	6.7' / 2030mm
Style / Shape	High Peak Frame Tent	Persons required for setup	2-3
Expandable	No	Occupancy	40 Sit Down Dinner
Custom Printing Available	Yes	Occupancy (cont.)	67 Cathedral Seating

**STEP 1. CHECK ITEM LIST (20' x 20' HPF-Weekender Tent)**

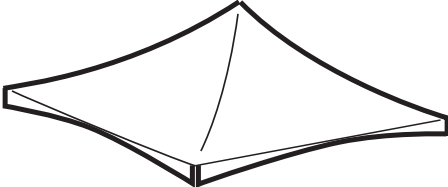
Item	Part #	Illustration (all parts available for replacement)	Quantity
HIP RAFTER	1	 SKU: BT-FHEP1	8
SPREADER	2	 SKU: BT-FHEP2	8
SPREADER (6.7ft)	3	 SKU: BT-FHEP3	4
BOTTOM LEG	4	 SKU: BT-FHEP4	4
HIP RAFTER	5	 SKU: BT-FHEP5	4
CENTER POLE	6	 SKU: BT-FHEP6	1
CORNER FITTINGS	7	 SKU: BT-FHEP7	4
CENTER POLE CROWN	8	 SKU: BT-FHEP8	1
BASE PLATE	9	 SKU: BT-FHEP9	4
STAKES	10	 SKU: BT-FHEP10	4
UPPER LEG	11	 SKU: BT-FHEP11	4
RATCHETS (ON THE CORNER)	12	 SKU: BT-FHEP12	4
RATCHETS STRAP (TIE DOWN)	13	 SKU: BT-FHEP13	4
PEG STAKE	14	 SKU: BT-FHEP14	4
BOLT M8 x 70	15	 SKU: BT-FHEP15	45
SCREW No.16	16	 SKU: BT-FHEP16	45
CANOPY TOP		 SKU: BT-FHE22WTT	

**STEP 2. ASSEMBLE FRAME**

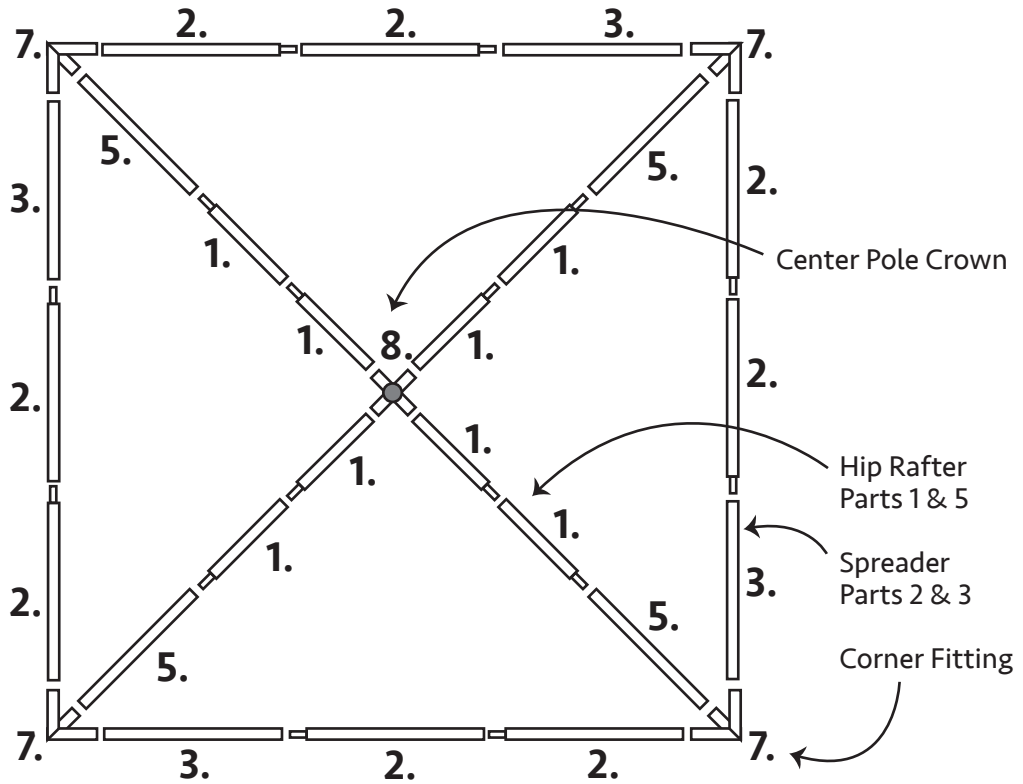

- Locate tent position, spread out parts in this area (see illustration)
- Start connecting the parts—first #2, #3 and #7, outside Spreaders and Corner Fittings
- Next put the #1 and #5s together—the last Rafter should include the Crown
- Insert all four completed Rafters into Corners
- Lastly lift the Rafter with Crown (to the proper height) and insert other three Rafters

**STEP 3. CANOPY**

Be careful to correctly position the corners and pull them tight— (use a ratchet strap for leverage if needed)

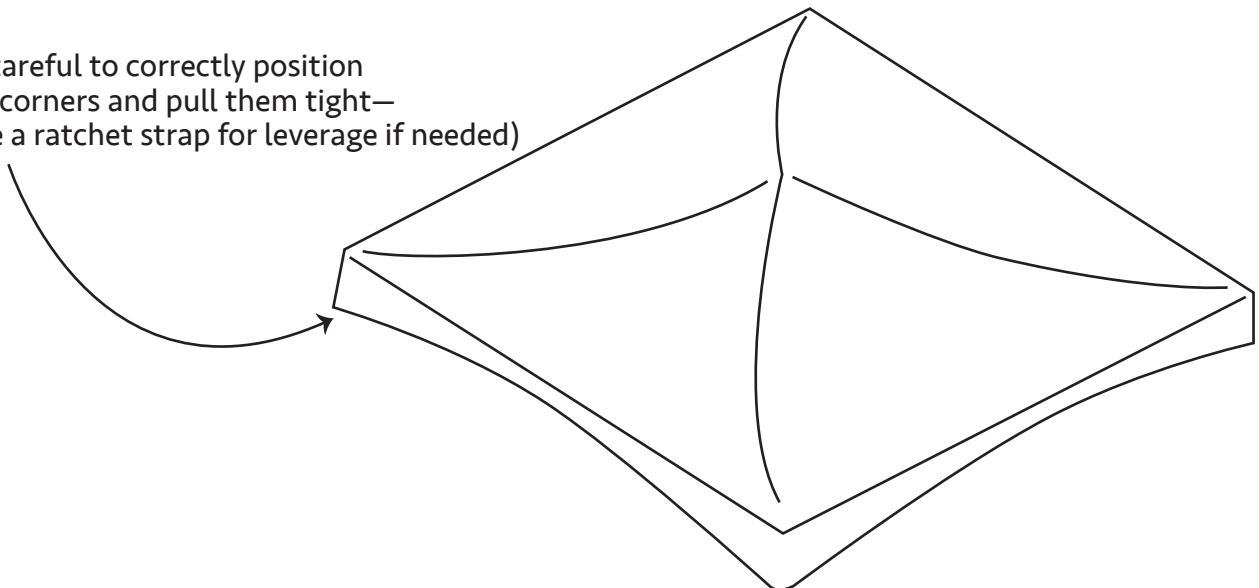

- Unfold Canopy/Top, place over the completed frame— Attach Corner Loops

STEP 4. CENTER POLE and LEGS

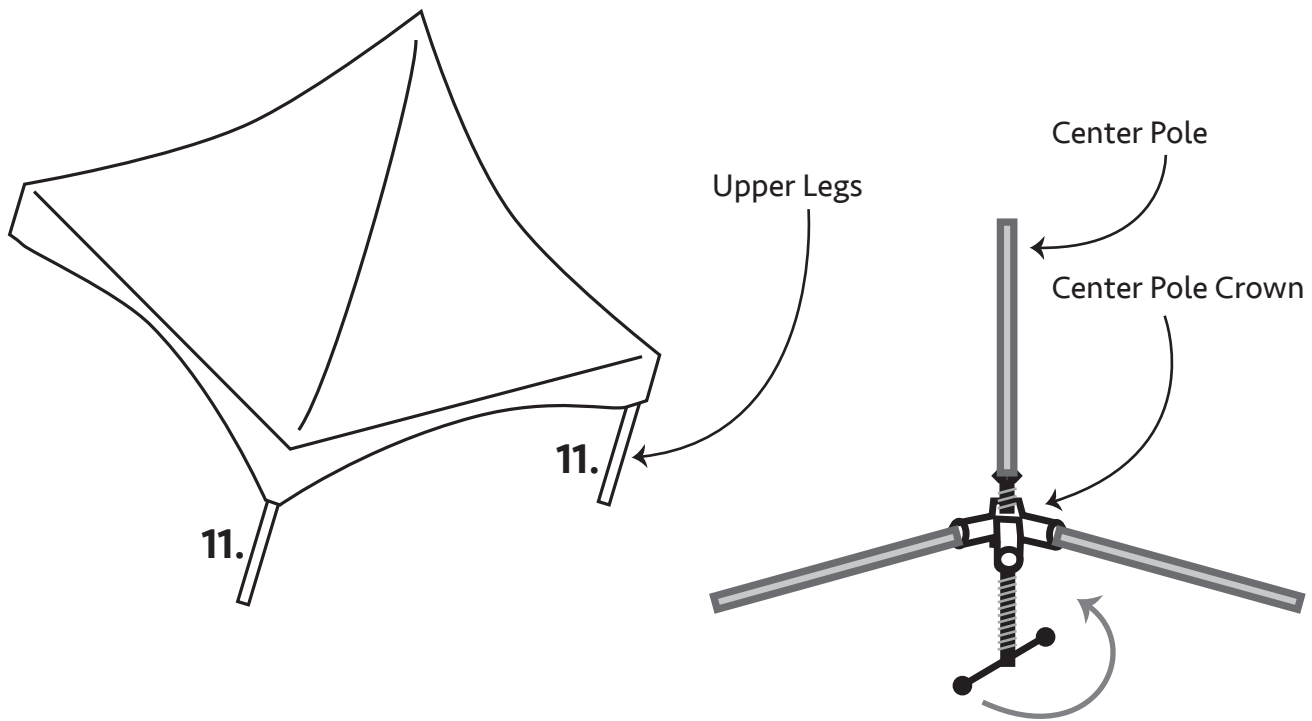

- Lift one corner of completed frame insert first and then second Leg (top)
- Put Center Pole in position and make contact with peak of Canopy—  
Turn Crown crank as needed, counter clockwise (*Double Check* this at the end of assembly)

STEP 5. LEGS

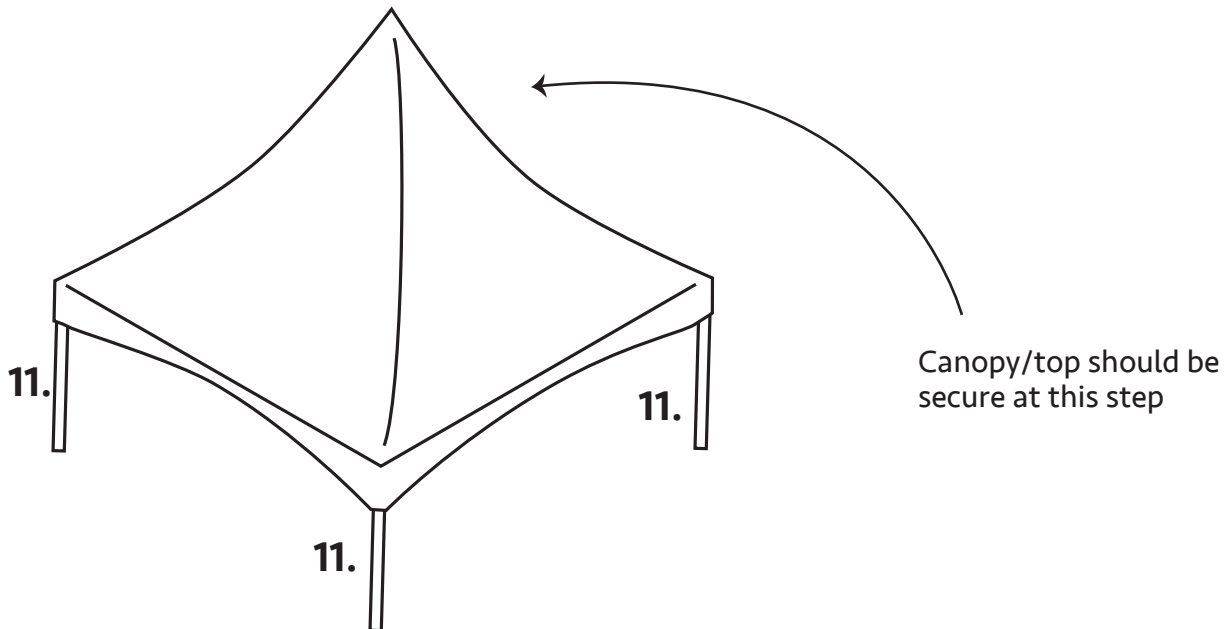

- Continue attaching the Upper Legs

STEP 6. BOTTOM LEGS and BASE PLATES

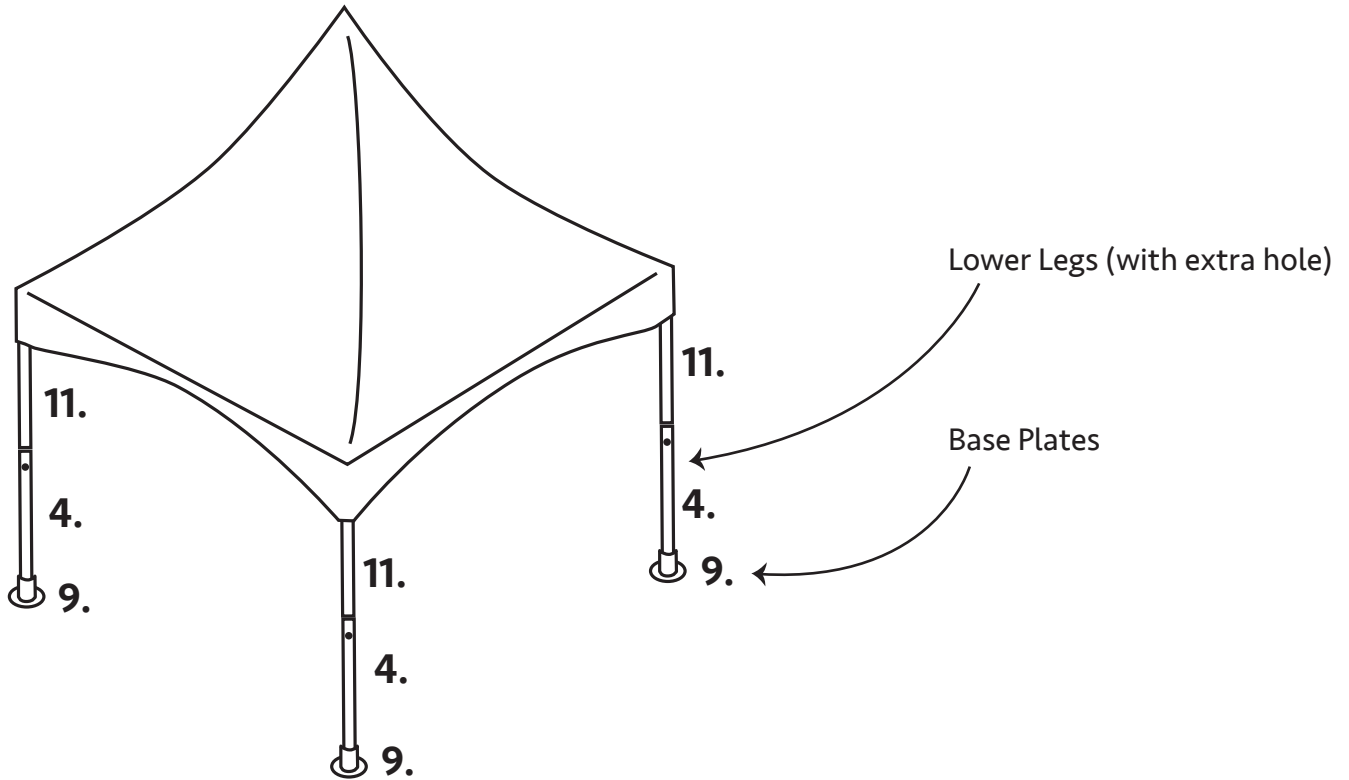

- Connect the Lower Legs to Upper Legs (using **nuts & bolts**)—and connect the Base Plates

STEP 7. ANCHOR STRAPS

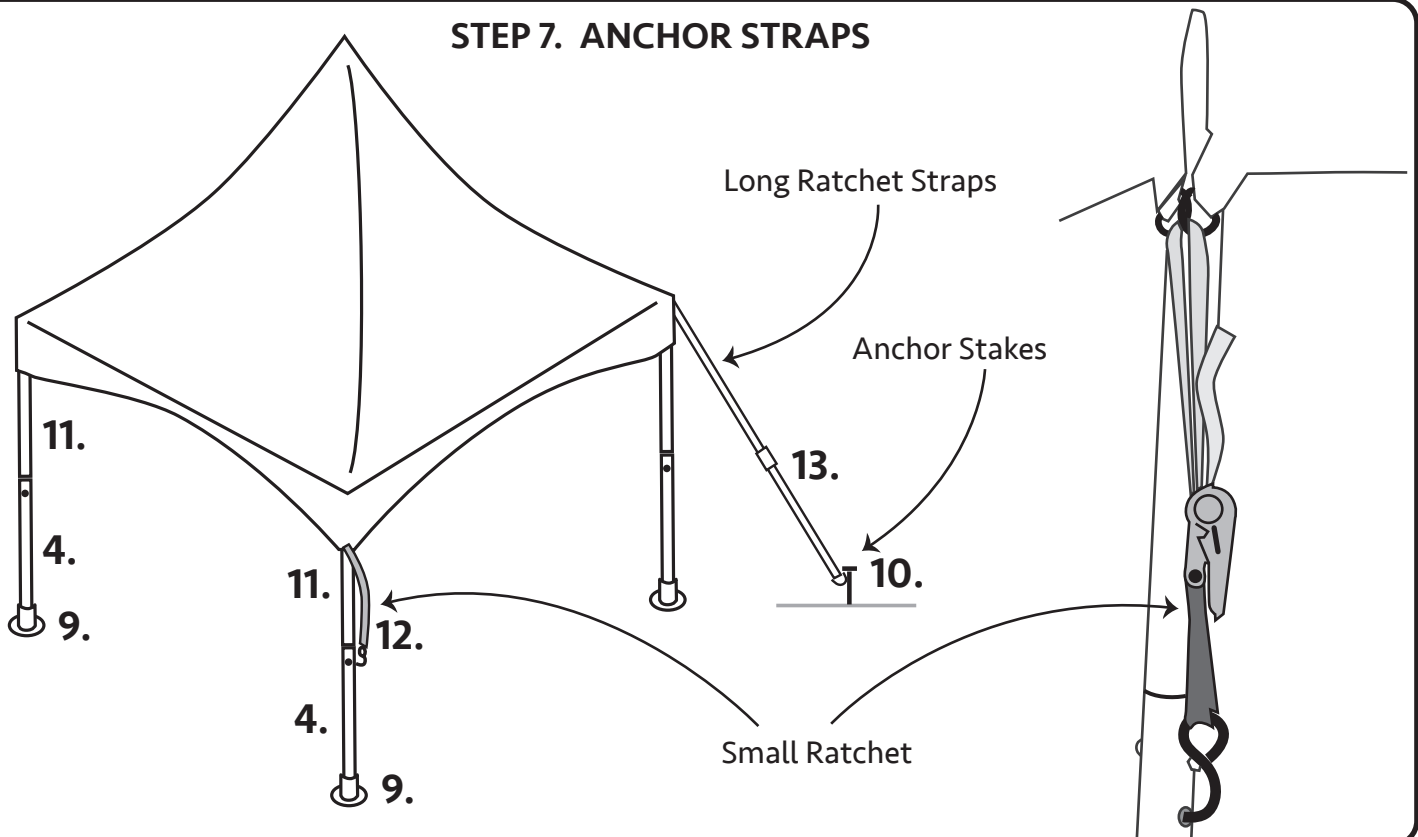

- Attach 1in. small Ratchets to the Legs
- Next the connect Long Tie Down Ratchet Straps to tent and Anchor Stakes



